



World Judo Championships - Doha 2023 Individuals

Qatar, Doha, 7-13 May 2023

-66 kg

Seniors (55)

POOL A

VIERU Denis (MDA)	1	VIERU D. (MDA)	33	VIERU D. (MDA)	01 s0/ 00 s2 [04:58]	
YOUNG Charlie (GBR)	2	FLICKER T. (ISR)	00 s1/ 01 s2 [04:00]	49	ABULADZE Y. (AIN)	00 s1/ 01 s1 [04:00]
FLICKER Tal (ISR)	2	ABULADZE Y. (AIN)	02 s0/ 00 s0 [01:47]	34	ABULADZE Y. (AIN)	10 s2/ 00 s2 [07:35]
ABULADZE Yago (AIN)	3	TILOVOV M. (UZB)	10 s2/ 00 s2 [05:23]	57	KHYAR W. (FRA)	00 s2/ 01 s0 [05:17]
RAHIMOV Serdar (TKM)	3	KHYAR W. (FRA)	01 s1/ 00 s2 [04:00]	50	KHYAR W. (FRA)	01 s2/ 00 s1 [07:47]
TILOVOV Mukhriddin (UZB)	4	PRECIADO L. (ECU)	00 s1/ 10 s2 [06:10]	35	LIMA W. (BRA)	00 s3/ 11 s1 [03:13]
EZZINE Wail (ALG)	4	EMOMALI N. (TJK)	00 s1/ 11 s1 [04:00]	36	LIMA W. (BRA)	00 s0/ 10 s0 [00:00]
KHYAR Walide (FRA)	5	EMOMALI Nurali (TJK)	00 s0/ 10 s0 [00:00]	37	MARGVELASHVILI V. (GEO)	01 s1/ 00 s2 [04:51]
AN Jaehong (KOR)	6	EMOMALI Nurali (TJK)	00 s0/ 10 s0 [00:00]	38	BATTOGTOKH E. (MGL)	00 s1/ 10 s0 [05:14]
PRECIADO Lenin (ECU)	6	LIMA W. (BRA)	00 s3/ 11 s1 [03:13]	39	ABE H. (JPN)	11 s0/ 00 s0 [02:07]
BUNCIC Strahinja (SRB)	7	LIMA W. (BRA)	00 s3/ 11 s1 [03:13]	40	GAITERO MARTIN A. (ESP)	10 s1/ 00 s2 [02:39]
EMOMALI Nurali (TJK)	7	ABE H. (JPN)	11 s0/ 00 s0 [02:07]	51	MARGVELASHVILI V. (GEO)	01 s0/ 00 s0 [04:00]
KODZHAKOV Ramazan (BRN)	8	ABE H. (JPN)	11 s0/ 00 s0 [02:07]	52	ABE H. (JPN)	01 s0/ 00 s2 [04:00]
LIMA Willian (BRA)	8	ABE H. (JPN)	11 s0/ 00 s0 [02:07]	53	YONDPONPERENLEI B. (MGL)	10 s1/ 00 s3 [06:03]

POOL B

MARGVELASHVILI Vazha (GEO)	9	MARGVELASHVILI V. (GEO)	37	MARGVELASHVILI V. (GEO)	01 s1/ 00 s2 [04:51]	
PERTELSON Oscar (EST)	10	PERTELSON O. (EST)	11 s0/ 00 s1 [01:42]	51	MARGVELASHVILI V. (GEO)	01 s0/ 00 s0 [04:00]
SETZ Martin (GER)	10	DE ANGELIS A. (LAT)	10 s1/ 00 s0 [02:15]	38	BATTOGTOKH E. (MGL)	00 s1/ 10 s0 [05:14]
DE ANGELIS Anthony (LAT)	11	BATTOGTOKH E. (MGL)	00 s0/ 10 s0 [01:48]	39	ABE H. (JPN)	11 s0/ 00 s0 [02:07]
PEDRO Edmilson (ANG)	11	ABE H. (JPN)	11 s0/ 00 s0 [02:07]	40	GAITERO MARTIN A. (ESP)	10 s1/ 00 s2 [02:39]
BOUSHITA Abderrahmane (MAR)	12	ABE H. (JPN)	11 s0/ 00 s0 [02:07]	52	ABE H. (JPN)	01 s0/ 00 s2 [04:00]
BATTOGTOKH Erkhembayar (MGL)	12	ABE H. (JPN)	11 s0/ 00 s0 [02:07]	53	YONDPONPERENLEI B. (MGL)	10 s1/ 00 s3 [06:03]
ABE Hifumi (JPN)	13	ABE H. (JPN)	11 s0/ 00 s0 [02:07]	54	MANZI E. (ITA)	00 s1/ 10 s0 [02:30]
ALHASSANE Ismael (NIG)	14	PIRAS M. (ITA)	00 s0/ 02 s0 [01:37]	59	YONDPONPERENLEI B. (MGL)	10 s0/ 00 s1 [01:28]
PIRAS Matteo (ITA)	14	GAITERO MARTIN A. (ESP)	10 s0/ 00 s2 [04:48]	60	MARUYAMA J. (JPN)	00 s2/ 01 s2 [06:23]
GAITERO MARTIN Alberto (ESP)	15	DEMIREL M. (TUR)	01 s0/ 00 s2 [04:20]	61	MARGVELASHVILI V. (GEO)	00 s0/ 11 s0 [01:38]
KATZ Nathan (AUS)	15	DEMIREL M. (TUR)	01 s0/ 00 s2 [04:20]	62	AN B. (KOR)	00 s3/ 10 s2 [06:26]
DEMIREL Muhammed (TUR)	16	BERLINER Ari (USA)	01 s0/ 00 s2 [04:20]	66	KHYAR W. (FRA)	00 s1/ 01 s0 [04:00]
BERLINER Ari (USA)	16	BERLINER Ari (USA)	01 s0/ 00 s2 [04:20]	66	KHYAR W. (FRA)	00 s1/ 01 s0 [04:00]

POOL C

YONDPONPERENLEI Baskhuu (MGL)	17	YONDPONPERENLEI B. (MGL)	41	YONDPONPERENLEI B. (MGL)	10 s1/ 00 s3 [06:03]	
NAGUCHEV Abrek (AIN)	18	NAGUCHEV A. (AIN)	10 s1/ 00 s0 [03:55]	53	YONDPONPERENLEI B. (MGL)	10 s0/ 00 s2 [03:03]
NURILLAEV Sardor (UZB)	18	SAIDABUROROV S. (TJK)	11 s2/ 00 s1 [03:54]	42	BORS DUMITRESCU L. (ROU)	00 s2/ 10 s0 [09:09]
SAIDABUROROV Shahboz (TJK)	19	BORS DUMITRESCU L. (ROU)	00 s0/ 11 s0 [02:03]	43	SAFAROV O. (AZE)	01 s1/ 00 s1 [06:59]
DZAVASHVILI Guram (UAE)	19	SAFAROV O. (AZE)	01 s1/ 00 s1 [06:59]	44	MANZI E. (ITA)	00 s3/ 10 s2 [06:07]
NKERO Fernand (GAB)	20	BOUBA D. (FRA)	00 s3/ 10 s2 [06:14]	45	KYRGYZBAYEV G. (KAZ)	00 s1/ 01 s2 [07:53]
BORS DUMITRESCU Lucian (ROU)	20	BOUBA D. (FRA)	00 s3/ 10 s2 [06:14]	46	AN B. (KOR)	00 s3/ 10 s2 [03:48]
SAFAROV Orkhan (AZE)	21	BOUBA D. (FRA)	00 s3/ 10 s2 [06:14]	47	MARUYAMA J. (JPN)	11 s1/ 00 s1 [02:04]
ABDELRAHMAN Ahmed (EGY)	22	BOUBA D. (FRA)	00 s3/ 10 s2 [06:14]	48	HERNANDEZ J. (COL)	00 s0/ 01 s1 [04:00]
BOUBA Daikii (FRA)	22	BOUBA D. (FRA)	00 s3/ 10 s2 [06:14]	49	HERNANDEZ J. (COL)	00 s0/ 01 s1 [04:00]
BALARJISHVILI Georgios (CYP)	23	BOUBA D. (FRA)	00 s3/ 10 s2 [06:14]	55	AN B. (KOR)	00 s3/ 10 s2 [03:48]
GERCHEV Yanislav (BUL)	23	BOUBA D. (FRA)	00 s3/ 10 s2 [06:14]	56	MARUYAMA J. (JPN)	11 s0/ 00 s0 [01:37]
MANZI Elios (ITA)	24	BOUBA D. (FRA)	00 s3/ 10 s2 [06:14]	57	KHYAR W. (FRA)	00 s2/ 01 s0 [05:17]
MANZI Elios (ITA)	24	BOUBA D. (FRA)	00 s3/ 10 s2 [06:14]	58	ABE H. (JPN)	00 s1/ 02 s1 [02:01]

POOL D

SHMAILOV Baruch (ISR)	25	SHMAILOV B. (ISR)	45	KYRGYZBAYEV G. (KAZ)	00 s1/ 01 s2 [07:53]	
KYRGYZBAYEV Gusman (KAZ)	26	KYRGYZBAYEV G. (KAZ)	10 s1/ 00 s2 [03:56]	46	AN B. (KOR)	00 s3/ 10 s1 [03:47]
POSTIGOS Juan (PER)	26	IZVOREANU R. (MDA)	10 s2/ 00 s1 [02:54]	47	MARUYAMA J. (JPN)	11 s1/ 00 s1 [02:04]
IZVOREANU Radu (MDA)	27	AN B. (KOR)	00 s3/ 10 s2 [07:29]	48	HERNANDEZ J. (COL)	00 s0/ 01 s1 [04:00]
SLAMBERGER Lennart (GER)	27	AN B. (KOR)	00 s3/ 10 s2 [07:29]	49	HERNANDEZ J. (COL)	00 s0/ 01 s1 [04:00]
AIBEK UULU Kubanychbek (KGZ)	28	AN B. (KOR)	00 s3/ 10 s2 [07:29]	55	AN B. (KOR)	00 s3/ 10 s2 [03:48]
AN Baul (KOR)	28	AN B. (KOR)	00 s3/ 10 s2 [07:29]	56	MARUYAMA J. (JPN)	11 s0/ 00 s0 [01:37]
MARUYAMA Joshiro (JPN)	29	MARUYAMA J. (JPN)	11 s1/ 00 s1 [02:04]	57	KHYAR W. (FRA)	00 s2/ 01 s0 [05:17]
POLIAK Matej (SVK)	30	POLIAK M. (SVK)	11 s0/ 00 s0 [01:25]	58	ABE H. (JPN)	00 s1/ 02 s1 [02:01]
RAMIREZ Isaiah (USA)	30	AGAMAMMEDOV H. (TKM)	00 s1/ 01 s1 [04:58]	59	YONDPONPERENLEI B. (MGL)	10 s0/ 00 s1 [01:28]
MUNGANDU Steven (ZAM)	31	AGAMAMMEDOV H. (TKM)	00 s1/ 01 s1 [04:58]	60	MARUYAMA J. (JPN)	00 s2/ 10 s1 [03:35]
AGAMAMMEDOV Hekim (TKM)	31	HERNANDEZ J. (COL)	00 s0/ 01 s1 [04:00]	61	MARGVELASHVILI V. (GEO)	00 s0/ 11 s0 [01:38]
GARCIA TORNE David (ESP)	32	HERNANDEZ J. (COL)	00 s0/ 01 s1 [04:00]	62	AN B. (KOR)	00 s3/ 10 s2 [06:26]
HERNANDEZ Juan (COL)	32	HERNANDEZ J. (COL)	00 s0/ 01 s1 [04:00]	66	KHYAR W. (FRA)	00 s1/ 01 s0 [04:00]

REPECHAGE

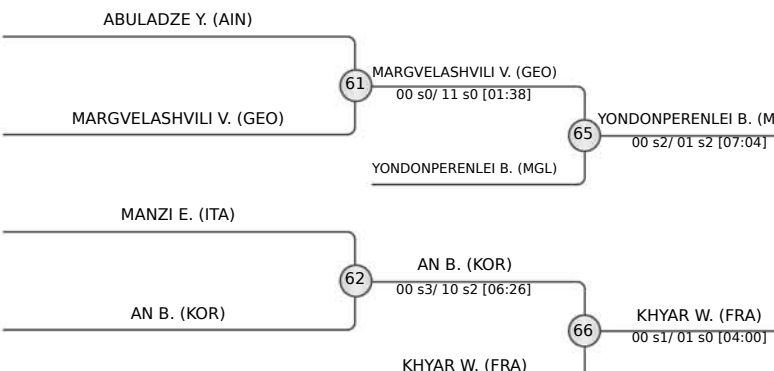

FINAL RESULTS	
1.	ABE Hifumi (JPN)
2.	MARUYAMA Joshiro (JPN)
3.	YONDPONPERENLEI Baskhuu (MGL)
5.	KHYAR Walide (FRA)
5.	MARGVELASHVILI Vazha (GEO)
7.	AN Baul (KOR)
7.	ABULADZE Yago (AIN)
7.	MANZI Elios (ITA)





World Judo Championships - Doha 2023 Individuals

Qatar, Doha, 7-13 May 2023

-73 kg

Seniors (55)

POOL A

1	SHAVDATUASHVILI Lasha GEO
2	DOUKKALI Hassan MAR
3	HASHIMOTO Soichi JPN
4	ESTRADA Magdiel CUB
5	KHOJAZODA Behruzi TJK
6	LEE Eunhyul KOR
7	ESPOSITO Giovanni ITA
8	STUMP Nils SUI
9	CIOGLU Bilal TUR
10	QING Daga CHN
11	NAKANO Keisei PHI
12	RODRIGUEZ Dominic USA
13	ARANDA OLALLA Jose Antonio ESP
14	PELIVAN Petru MDA

1	SHAVDATUASHVILI L. (GEO)
2	HASHIMOTO S. (JPN)
3	KHOJAZODA B. (TJK)
4	ESPOSITO G. (ITA)
5	STUMP N. (SUI)
6	QING D. (CHN)
7	RODRIGUEZ D. (USA)
8	PELIVAN P. (MDA)
9	YULDOSHEV M. (UZB)
10	TSOUTLASVILI M. (GRE)
11	UMAYEV A. (BEL)
12	MAKHMADBEKOV M. (AIN)
13	NOMONOV O. (UZB)
14	GABA J. (FRA)
15	HRISTOV M. (BUL)
16	BUTBUL T. (ISR)
17	HEYDAROV H. (AZE)
18	OSMANOV A. (MDA)
19	NJIE F. (GAM)
20	YONEZUKA J. (USA)
21	MARGELIDON A. (CAN)
22	SAGYNALIEV C. (KGZ)
23	CARDOSO G. (MEX)
24	CASES ROCA S. (ESP)
25	TSEND-OCHIR T. (MGL)
26	BEN CHALBI A. (TUN)
27	KARAPETIAN Ferdinand ARM
28	DRIS Messaoud Redouane ALG
29	OLIN Valtter FIN
30	LOMBARDO Manuel ITA
31	SHAMSHAYEV Daniyar KAZ
32	DEMIREL Umalt TUR
33	KANG Heoncheol KOR
34	HAMAD Sulaiman KSA
35	GJAKOVA Akil KOS
36	SULCA Adrian ROU

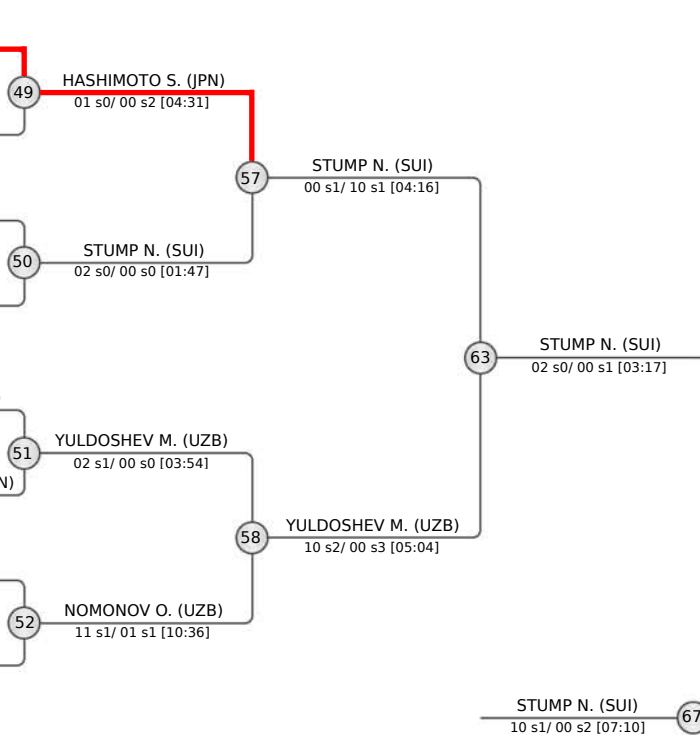

POOL B

9	YULDOSHEV Murodjon UZB
10	TSOUTLASVILI Michail GRE
11	TURDUBAEV Ertur KGZ
12	UMAYEV Abdul Malik BEL
13	MAJIDI Kavan IRT
14	SMAGULOV Zhansay KAZ
15	MAKHMADBEKOV Makhmadbek AIN
16	NOMONOV Obidkhon UZB
17	RAICU Alexandru ROU
18	GABA Joan-Benjamin FRA
19	STODOLSKI Adam POL
20	HRISTOV Mark BUL
21	BATZAYA Erdenebayar MGL
22	BUTBUL Tohar ISR

9	YULDOSHEV M. (UZB)
10	TSOUTLASVILI M. (GRE)
11	UMAYEV A. (BEL)
12	MAKHMADBEKOV M. (AIN)
13	NOMONOV O. (UZB)
14	GABA J. (FRA)
15	HRISTOV M. (BUL)
16	BUTBUL T. (ISR)
17	HEYDAROV H. (AZE)
18	OSMANOV A. (MDA)
19	NJIE F. (GAM)
20	YONEZUKA J. (USA)
21	MARGELIDON A. (CAN)
22	SAGYNALIEV C. (KGZ)
23	CARDOSO G. (MEX)
24	CASES ROCA S. (ESP)
25	TSEND-OCHIR T. (MGL)
26	BEN CHALBI A. (TUN)
27	KARAPETIAN Ferdinand ARM
28	DRIS Messaoud Redouane ALG
29	OLIN Valtter FIN
30	LOMBARDO Manuel ITA
31	SHAMSHAYEV Daniyar KAZ
32	DEMIREL Umalt TUR
33	KANG Heoncheol KOR
34	HAMAD Sulaiman KSA
35	GJAKOVA Akil KOS
36	SULCA Adrian ROU

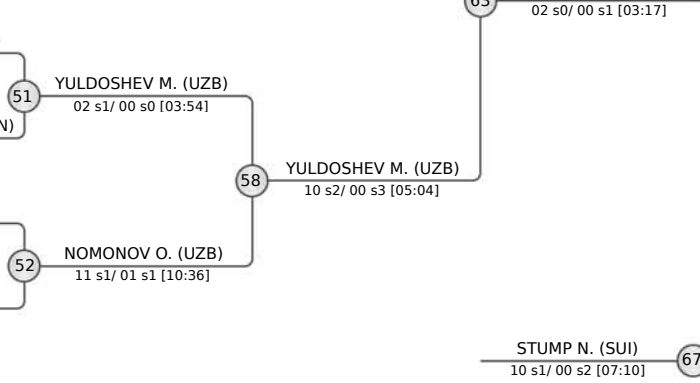

POOL C

17	HEYDAROV Hidayat AZE
18	HOJAK Martin SLO
19	OSMANOV Adil MDA
20	HOUSSEIN Aden-Alexandre DJI
21	NJIE Faye GAM
22	GABLER Alexander Bernd GER
23	YONEZUKA Jack USA
24	MARGELIDON Arthur CAN
25	WONG Alonso PER
26	SAGYNALIEV Chyngyzkhan KGZ
27	CARDOSO Gilberto MEX
28	GREEN Joshua IRL
29	CASES ROCA Salvador ESP
30	MORKA Ksawery POL

17	HEYDAROV H. (AZE)
18	OSMANOV A. (MDA)
19	NJIE F. (GAM)
20	YONEZUKA J. (USA)
21	MARGELIDON A. (CAN)
22	SAGYNALIEV C. (KGZ)
23	CARDOSO G. (MEX)
24	CASES ROCA S. (ESP)
25	TSEND-OCHIR T. (MGL)
26	BEN CHALBI A. (TUN)
27	KARAPETIAN Ferdinand ARM
28	DRIS Messaoud Redouane ALG
29	OLIN Valtter FIN
30	LOMBARDO Manuel ITA
31	SHAMSHAYEV Daniyar KAZ
32	DEMIREL Umalt TUR
33	KANG Heoncheol KOR
34	HAMAD Sulaiman KSA
35	GJAKOVA Akil KOS
36	SULCA Adrian ROU

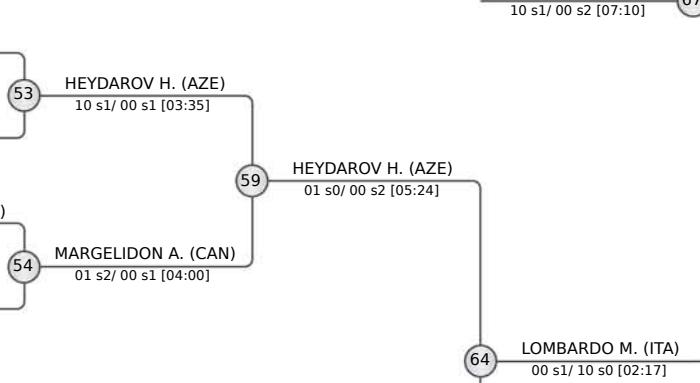

POOL D

25	TSEND-OCHIR Tsogtbaatar MGL
26	KUMAR Arun IND
27	BEN CHALBI Aledidine TUN
28	KARAPETIAN Ferdinand ARM
29	DRIS Messaoud Redouane ALG
30	OLIN Valtter FIN
31	LOMBARDO Manuel ITA
32	SHAMSHAYEV Daniyar KAZ
33	DEMIREL Umalt TUR
34	KANG Heoncheol KOR
35	HAMAD Sulaiman KSA
36	GJAKOVA Akil KOS
37	SULCA Adrian ROU

25	TSEND-OCHIR T. (MGL)
26	BEN CHALBI A. (TUN)
27	KARAPETIAN Ferdinand ARM
28	DRIS M. (ALG)
29	OLIN V. (FIN)
30	LOMBARDO M. (ITA)
31	SHAMSHAYEV D. (KAZ)
32	DEMIREL U. (TUR)
33	KANG H. (KOR)
34	HAMAD S. (KSA)
35	GJAKOVA A. (KOS)
36	SULCA A. (ROU)

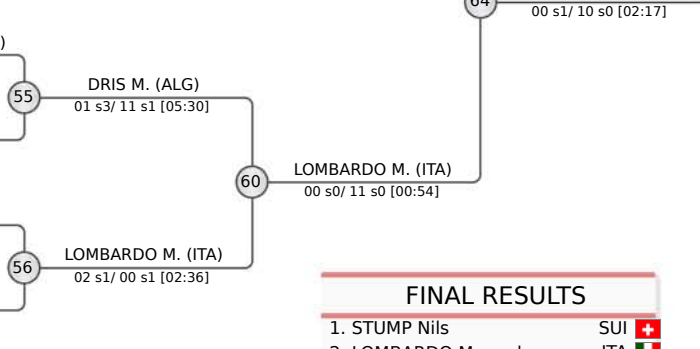

REPECHAGE

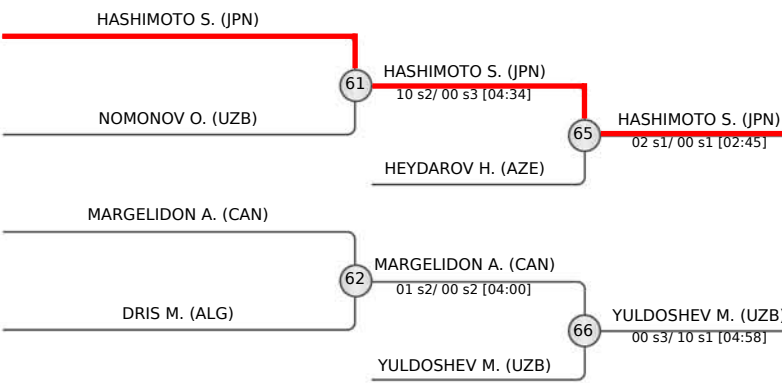

FINAL RESULTS		
1.	STUMP Nils	SUI
2.	LOMBARDO Manuel	ITA
3.	HASHIMOTO Soichi	JPN
4.	YULDOSHEV Murodjon	UZB
5.	HEYDAROV Hidayat	AZE
6.	MARGELIDON Arthur	CAN
7.	NOMONOV Obidkhon	UZB
8.	DRIS Messaoud Redouane	ALG





World Judo Championships - Doha 2023 Individuals

Qatar, Doha, 7-13 May 2023

-52 kg

Seniors (46)

POOL A

1	KRASNIQI D. (KOS)	33	KRASNIQI D. (KOS)
2	BALLHAUS M. (GER)	00 s0/ 10 s0 [01:27]	10 s2/ 00 s2 [04:37]
3	RYHEUL A. (BEL)	00 s3/ 10 s1 [06:19]	RYHEUL A. (BEL)
4	SIDEROT M. (POR)	11 s2/ 00 s1 [03:55]	34
5	PEREZ BOX A. (ESP)		
6	JANG S. (KOR)	00 s0/ 10 s0 [01:36]	35
7	KADAMBOEVA S. (UZB)	00 s2/ 10 s0 [03:54]	36
8	ZHU Y. (CHN)	00 s2/ 01 s2 [06:15]	

POOL B

9	BUCHARD A. (FRA)	37	BUCHARD A. (FRA)
10	DELGADO A. (USA)	00 s2/ 11 s0 [01:50]	01 s0/ 00 s2 [04:00]
11	FIORA S. (ARG)	00 s1/ 02 s0 [03:26]	38
12	MAMMADALIYEVA G. (AZE)	00 s1/ 02 s0 [03:04]	
13	ABE U. (JPN)		
14	PULJIZ A. (CRO)	02 s0/ 00 s1 [02:07]	39
15	KOCHER F. (SUI)	10 s0/ 00 s1 [01:49]	40
16	CHRISTODOULIDOU A. (CYP)	10 s0/ 00 s0 [02:03]	

POOL C

17	PUPP R. (HUN)	41	PUPP R. (HUN)
18	VAN SNICK C. (BEL)	00 s0/ 11 s0 [00:37]	11 s0/ 01 s3 [04:48]
19	EASTON T. (AUS)	02 s0/ 00 s0 [01:35]	42
20	BUET L. (SEN)	02 s0/ 00 s0 [02:13]	
21	GIUFFRIDA O. (ITA)	43	GIUFFRIDA O. (ITA)
22	VALIYEVA A. (AZE)	00 s1/ 10 s2 [02:47]	02 s0/ 00 s1 [03:37]
23	IRAQUI S. (MAR)	00 s2/ 01 s0 [06:46]	44
24	KUZNETSOVA A. (AIN)	01 s0/ 00 s1 [04:00]	

POOL D

25	KELDIYOROVA D. (UZB)	45	KELDIYOROVA D. (UZB)
26	LOPEZ SHERIFF E. (ESP)	10 s0/ 00 s0 [01:02]	10 s0/ 00 s1 [04:15]
27	DEGUCHI K. (CAN)	10 s0/ 01 s0 [03:34]	46
28	LIU B. (CHN)	10 s3/ 10 s3 [00:00]	
29	PRIMO G. (ISR)	47	PRIMO G. (ISR)
30	MYAGMARSUREN N. (MGL)	10 s0/ 00 s3 [01:42]	
31	KALETA A. (POL)	00 s0/ 10 s0 [01:50]	48
32	NDIAYE B. (SUI)	00 s2/ 10 s0 [03:06]	

REPECHAGE

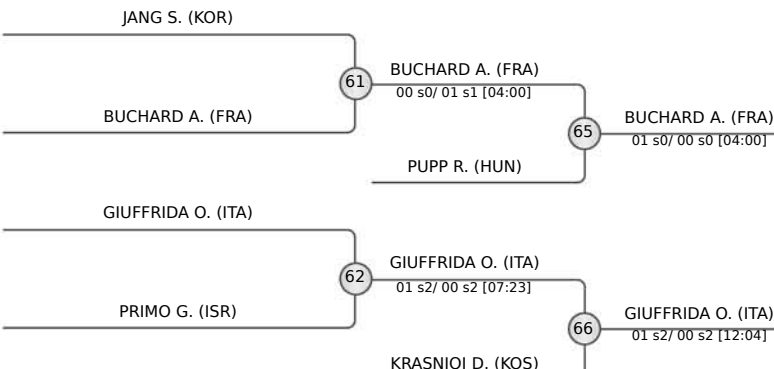

FINAL RESULTS

1.	ABE Uta	JPN
2.	KELDIYOROVA Diyora	UZB
3.	BUCHARD Amandine	FRA
4.	GIUFFRIDA Odette	ITA
5.	PUPP Reka	HUN
6.	KRASNIQI Distria	KOS
7.	JANG Seyun	KOR
8.	PRIMO Gefen	ISR



