



# Tashkent World Championships Senior 2022

## Uzbekistan, Tashkent, 6-12 Oct 2022

**-60 kg**  
Seniors (42)

**POOL A**

1	YANG Yung Wei	TPE
2	KUWABARA Allan	BRA
3	HALL Samuel	GBR
4	SADDIKI Younes	MAR
5	ENKHTAIVAN Sumiyabazar	MGL
6	SAMY Yousry	EGY
7	HUSEYNOV Karamat	AZE
8	SMETOV Yeldos	KAZ
9	KOKOLAYEV Matan	ISR
10	REVOL Cedric	FRA

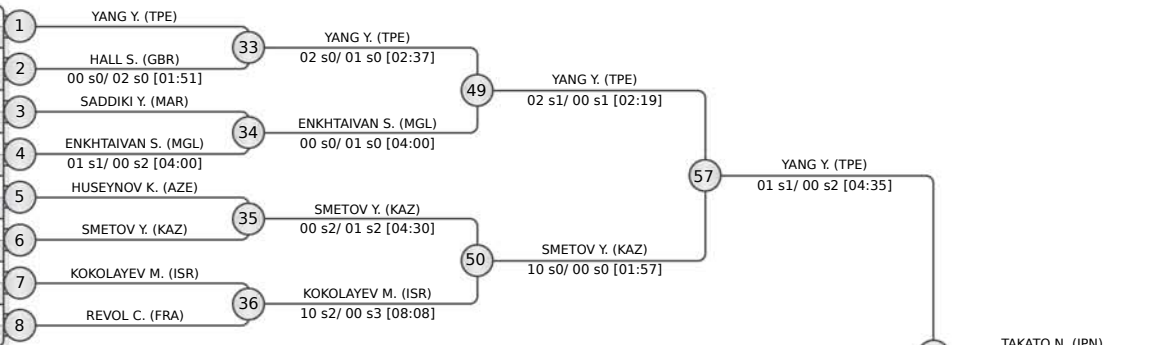

**POOL B**

9	GARRIGOS Francisco	ESP
10	STARKEL David	SLO
11	YILDIZ Salih	TUR
12	KHALMATOV Dilshot	UKR
13	RASHNONEZHAD Mohammad	IRT
14	IJMAYEV Hakberdi	TKM
15	TAKATO Naohisa	JPN
16	PLAFKY Moritz	GER
17	JEON Seungbeom	KOR
18	KARAKIZIDI Savva	GRE
19	PORTE VALDIVIEZO Danny	CUB

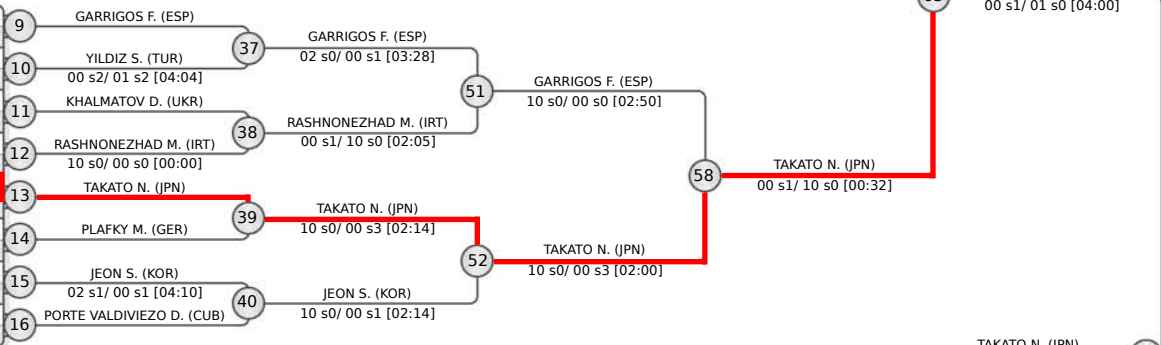

**POOL C**

17	VERSTRAETEN Jorre	BEL
18	SEIBOU KANGAYE Souleymane	NIG
19	AUER Marcus	AUT
20	PANTANO Angelo	ITA
21	SHAMSHADIN Magzhan	KAZ
22	TSJAKADOEVA Tornike	NED
23	VALADIER PICARD Romain	FRA
24	YRYSBEKOV Khanbolot	KGZ
25	ENKHTAIVAN Ariunbold	MGL
26	PULKRABEK David	CZE

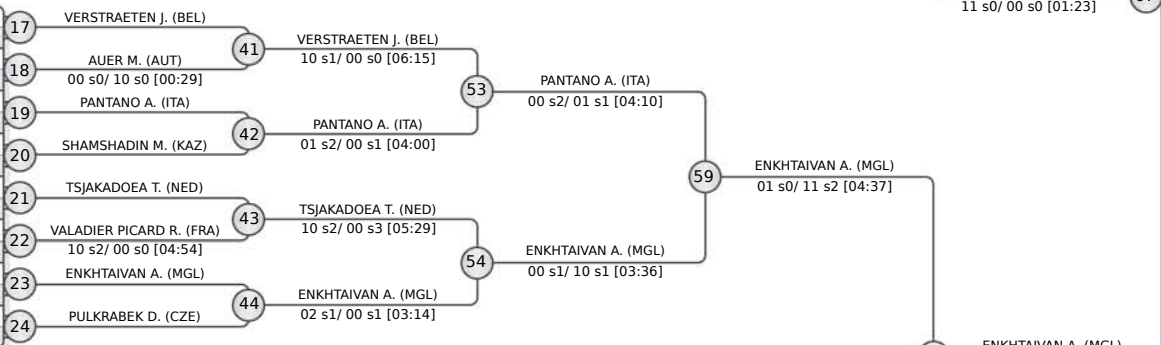

**POOL D**

25	CHKHVIMIANI Lukhumi	GEO
26	WOLCZAK Yam	ISR
27	DIAZ Adonis	USA
28	DABONE Daouda	CIV
29	ZULU Simon	ZAM
30	OMIROV Aybek	TKM
31	LESIUK Artem	UKR
32	BARATOV Dilshodbek	UZB
33	AKKASH Mohamad	IRT
34	LEE Harim	KOR
35	LOPES Rodrigo Costa	POR

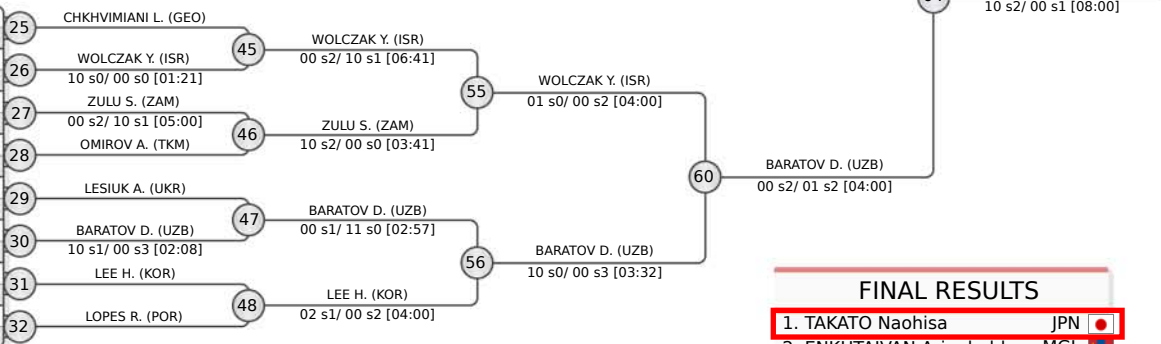

### FINAL RESULTS

1.	TAKATO Naohisa	JPN
2.	ENKHTAIVAN Ariunbold	MGL
3.	SMETOV Yeldos	KAZ
4.	YANG Yung Wei	TPE
5.	BARATOV Dilshodbek	UZB
6.	WOLCZAK Yam	ISR
7.	PANTANO Angelo	ITA
8.	GARRIGOS Francisco	ESP

**REPECHAGE**

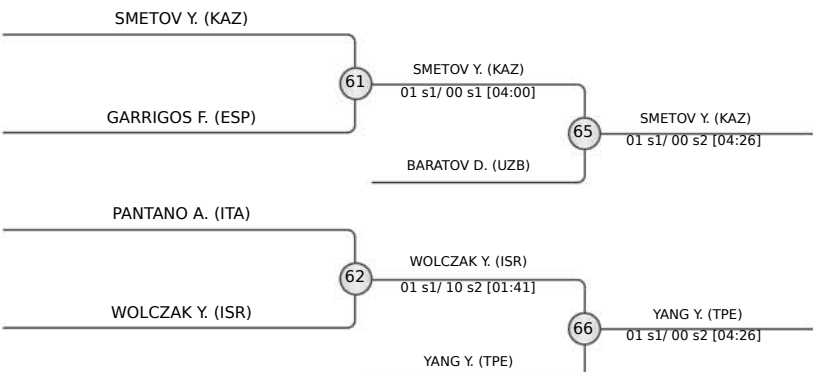



# Tashkent World Championships Senior 2022

## Uzbekistan, Tashkent, 6-12 Oct 2022

# -66 kg

Seniors (44)

**POOL A**

1	VIERU Denis (MDA)	33	VIERU D. (MDA)
2	BUNCIC Strahinja (SRB)	34	BUNCIC S. (SRB)
3	FLICKER Tai (ISR)	35	SLAMBERGER L. (GER)
4	SLAMBERGER Lennart (GER)	36	GAITERO MARTIN A. (ESP)
5	POSTIGOS Juan (PER)	37	GAITERO MARTIN A. (ESP)
6	GAITERO MARTIN Alberto (ESP)	38	SAFAROV O. (AZE)
7	SAFAROV Orkhan (AZE)	39	SAFAROV O. (AZE)
8	WAIZENEGGER Freddy (SUI)	40	SAFAROV O. (AZE)
	ALHASSANE Ismael (NIG)	41	IADOV B. (UKR)
	NURILLAEV Sardor (UZB)	42	IADOV B. (UKR)
	IADOV Bogdan (UKR)	43	IADOV B. (UKR)

**POOL B**

9	ABE Hifumi (JPN)	44	ABE H. (JPN)
10	TAKABATAKE Eric (BRA)	45	SAHA L. (FIN)
11	SAHA Luukas (FIN)	46	POLANCO O. (CUB)
12	POLANCO Orlando (CUB)	47	EMOMALI N. (TJK)
13	EMOMALI Nurali (TJK)	48	EMOMALI N. (TJK)
14	YONDONPERENLEI Baskhuu (MGL)	49	YONDONPERENLEI B. (MGL)
15	ABDELMAWGOUD Mohamed (EGY)	50	KODZHAKOV R. (BRN)
16	KODZHAKOV Ramazan (BRN)	51	KODZHAKOV R. (BRN)
	MANZI Elios (ITA)	52	MANZI E. (ITA)
	TEMEKOV Bozhidar (BUL)	53	MANZI E. (ITA)
	MUNGANDU Steven (ZAM)	54	MANZI E. (ITA)

**POOL C**

17	MARGVELASHVILI Vazha (GEO)	55	MARGVELASHVILI V. (GEO)
18	BOUSHITA Abderrahmane (MAR)	56	BOUSHITA A. (MAR)
19	DEMIREL Muhammed (TUR)	57	MARGVELASHVILI V. (GEO)
20	MARANDIAN Karo (UKR)	58	MARGVELASHVILI V. (GEO)
21	RAMIREZ Isaiah (USA)	59	MARANDIAN K. (UKR)
22	LIMA Willian (BRA)	60	MARANDIAN K. (UKR)
23	IZVOREANU Radu (MDA)	61	LIMA W. (BRA)
24	GERCHEV Yanislav (BUL)	62	LIMA W. (BRA)
25	VERHORSTERT Ivo (NED)	63	MARUYAMA J. (JPN)
26	MARUYAMA Joshiro (JPN)	64	MARUYAMA J. (JPN)
27	BORS DUMITRESCU Lucian (ROU)	65	MARUYAMA J. (JPN)

**POOL D**

25	AN Baul (KOR)	66	AN B. (KOR)
26	PIRAS Matteo (ITA)	67	KYRGYZBAYEV G. (KAZ)
27	KYRGYZBAYEV Gusman (KAZ)	68	KYRGYZBAYEV G. (KAZ)
28	NIETO CHINARRO Adrian (ESP)	69	NIETO CHINARRO A. (ESP)
29	NAJAFOV Yashar (AZE)	70	NIETO CHINARRO A. (ESP)
30	NOSRATI Miad (IRT)	71	NIETO CHINARRO A. (ESP)
31	SHMAILOV Baruch (ISR)	72	SHMAILOV B. (ISR)
32	SANCHO CHINCHILA Ian (CRC)	73	SHMAILOV B. (ISR)
33	GANBOLD Kherlen (MGL)	74	SHMAILOV B. (ISR)
34	KHYAR Walide (FRA)	75	KHYAR W. (FRA)
35	EZZINE Wail (ALG)	76	KHYAR W. (FRA)

**REPECHAGE**

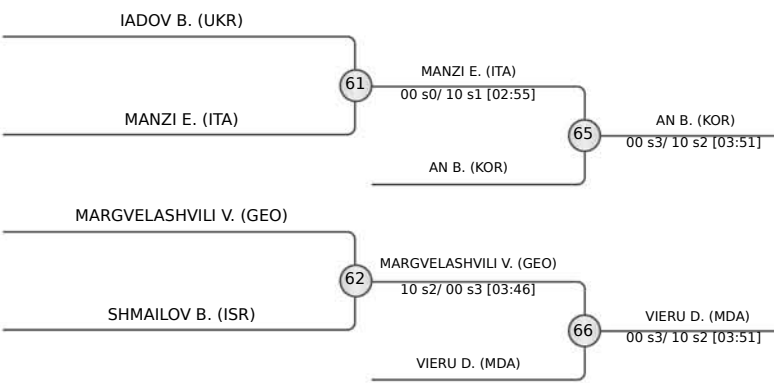

### FINAL RESULTS

1.	ABE Hifumi	JPN
2.	MARUYAMA Joshiro	JPN
3.	AN Baul	KOR
3.	VIERU Denis	MDA
5.	MANZI Elios	ITA
7.	MARGVELASHVILI Vazha	GEO
7.	SHMAILOV Baruch	ISR
7.	IADOV Bogdan	UKR





# Tashkent World Championships Senior 2022

## Uzbekistan, Tashkent, 6-12 Oct 2022

# -73 kg

Seniors (51)

POOL A

1	SHAVDATUASHVILI Lasha (GEO)	33	SHAVDATUASHVILI L. (GEO)
2	STUMP Nils (SUI)	34	ESPOSITO G. (ITA)
3	SARAKHONOV Muhammadrahim (TJK)	35	HASHIMOTO S. (JPN)
4	ESPOSITO Giovanni (ITA)	36	YULDOSHEV M. (UZB)
5	OLIN Valtteri (FIN)	37	BUTBUL T. (ISR)
6	SANCHO Julian (CRC)	38	LEE E. (KOR)
7	HASHIMOTO Soichi (JPN)	39	CARGNIN D. (BRA)
8	DRIS Messaoud Redouane (ALG)	40	GABLER A. (GER)
	GABA Joan-Benjamin (FRA)	41	TSEND-OCHIR T. (MGL)
	JAUHARI Jawid (IRT)	42	SULCA A. (ROU)
	TURDUBAEV Ertur (KGZ)	43	MARGELIDON A. (CAN)
	NJIE Faye (GAM)	44	ESTRADA M. (CUB)
	YULDOSHEV Murodjon (UZB)	45	HEYDAROV H. (AZE)

POOL B

9	BUTBUL Tohar (ISR)	51	BUTBUL T. (ISR)
10	HRISTOV Mark (BUL)	52	CARGNIN D. (BRA)
11	TSOUTLASVILI Michail (GRE)	53	TSEND-OCHIR T. (MGL)
12	YONEZUKA Jack (USA)	54	MARGELIDON A. (CAN)
13	SHAMSHAYEV Daniyar (KAZ)	55	HEYDAROV H. (AZE)
14	LEE Eunhyul (KOR)	56	LOMBARDO M. (ITA)
15	ORUJOV Rustam (AZE)	57	HASHIMOTO S. (JPN)
16	RAICU Alexandru (ROU)	58	BUTBUL T. (ISR)
17	CARGNIN Daniel (BRA)	59	TSEND-OCHIR T. (MGL)
18	GABLER Alexander Bernd (GER)	60	LOMBARDO M. (ITA)
19	STODOLSKI Adam (POL)	61	CARGNIN D. (BRA)
20	TORNAL Antonio (DOM)	62	HEYDAROV H. (AZE)

POOL C

17	TSEND-OCHIR Tsogtbaatar (MGL)	63	HASHIMOTO S. (JPN)
18	LEVIN Ido (ISR)	64	TSEND-OCHIR T. (MGL)
19	HAMAD Sulaiman (KSA)	65	CARGNIN D. (BRA)
20	SULCA Adrian (ROU)	66	HEYDAROV H. (AZE)
21	HOJAK Martin (SLO)	67	TSEND-OCHIR T. (MGL)
22	MROWCZYNSKI Wiktor (POL)		
23	MARGELIDON Arthur (CAN)		
24	QING Daga (CHN)		
25	POCHOP Daniel (CZE)		
26	WANDTKE Igor (GER)		
27	BEN CHALBI Aleddine (TUN)		
28	ESTRADA Magdiel (CUB)		
29	ALIKAJ Ahmad (IRT)		

POOL D

25	HEYDAROV Hidayat (AZE)	68	HEYDAROV H. (AZE)
26	UMAYEV Abdul Malik (BEL)	69	UMAYEV A. (BEL)
27	ABDELMOUATY Ali (EGY)	70	AKHADOV S. (UZB)
28	CASES ROCA Salvador (ESP)	71	AKHADOV S. (UZB)
29	RODRIGUEZ Dominic (USA)	72	STERPU V. (MDA)
30	AKHADOV Shakhram (UZB)	73	STERPU V. (MDA)
31	STERPU Victor (MDA)	74	KHOJAZODA B. (TJK)
32	KHOJAZODA Behruzi (TJK)	75	AXUS Benjamin (FRA)
	AXUS Benjamin (FRA)	76	SAGYNALIEV Chyngyzkhan (KGZ)
	SAGYNALIEV Chyngyzkhan (KGZ)	77	NAKANO Keisei (PHI)
	NAKANO Keisei (PHI)	78	LOMBARDO M. (ITA)
	LOMBARDO Manuel (ITA)	79	LOMBARDO M. (ITA)
	KHOMULA Artem (UKR)	80	KHOMULA A. (UKR)

REPECHAGE

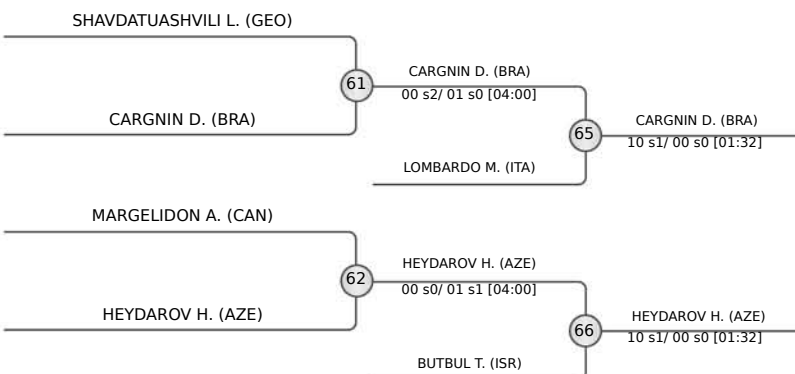

### FINAL RESULTS

1. TSEND-OCHIR Tsogtbaatar (MGL)
2. HASHIMOTO Soichi (JPN)
3. CARGNIN Daniel (BRA)
3. HEYDAROV Hidayat (AZE)
5. LOMBARDO Manuel (ITA)
7. BUTBUL Tohar (ISR)
7. MARGELIDON Arthur (CAN)
7. SHAVDATUASHVILI Lasha (GEO)



# Tashkent World Championships Senior 2022

## Uzbekistan, Tashkent, 6-12 Oct 2022

# -90 kg

## Seniors (49)

**POOL A**

1	BOBONOV Davlat (UZB)	1	BOBONOV D. (UZB)
2	ZILKA Peter (SVK)	33	BOBONOV D. (UZB)
3	FLORENTINO Robert (DOM)	10 s0/00 s0 [00:00]	11 s1/01 s3 [05:10]
4	HAN Juyeop (KOR)	34	HAN J. (KOR)
5	NERPEL Gergely (HUN)	01 s1/00 s2 [04:00]	10 s1/00 s1 [01:52]
6	GRIGORIAN Aram (UAE)	35	VAN T END N. (NED)
7	ZGANK Mihael (TUR)	00 s2/10 s2 [04:42]	10 s2/00 s2 [05:49]
8	VAN T END Noel (NED)	36	IVANOV I. (BUL)
			01 s0/00 s0 [04:00]
			01 s1/00 s2 [04:00]
			01 s0/00 s0 [04:00]

**POOL B**

9	SILVA MORALES Ivan Felipe (CUB)	9	SILVA MORALES I. (CUB)
10	MAJDOV Nemanja (SRB)	37	SILVA MORALES I. (CUB)
11	GOTONOAGA Dorin (MDA)	10 s1/00 s3 [02:27]	01 s1/00 s2 [06:27]
12	FEUILLET Remi (MRI)	38	KLAMMERT D. (CZE)
13	KHAMZA Didar (KAZ)	39	BEKAURI L. (GEO)
14	KLAMMERT David (CZE)	00 s2/01 s2 [04:00]	02 s0/00 s0 [02:51]
15	BEKAURI Lasha (GEO)	40	MACEDO R. (BRA)
16	CASSAR Harrison (AUS)	41	PARLATI C. (ITA)
17	MASHIYAMA Kosuke (JPN)	00 s2/10 s0 [03:23]	00 s2/10 s2 [05:30]
18	MACEDO Rafael (BRA)	42	TSELIDIS T. (GRE)
19	KALJULAJD Klen Kristofer (EST)	43	TRIPPEL E. (GER)
20	SHEROV Erlan (KGZ)	44	GOMES M. (BRA)
			01 s1/11 s0 [01:57]
			10 s0/00 s0 [00:25]
			00 s0/02 s0 [02:27]

**POOL C**

21	MEHDIYEV Mammadali (AZE)	17	MEHDIYEV M. (AZE)
22	PARLATI Christian (ITA)	18	PARLATI C. (ITA)
23	KNAUF Alexander (USA)	19	BRASNJOVIC Darko (SRB)
24	BRASNJOVIC Darko (SRB)	20	TSELIDIS T. (GRE)
25	TSELIDIS Theodoros (GRE)	21	BORCHASHVILI Wachid (AUT)
26	BORCHASHVILI Wachid (AUT)	22	TRIPPEL E. (GER)
27	TRIPPEL Eduard (GER)	23	SMINK J. (NED)
28	BREYTENBACH Thomas-Laszlo (RSA)	24	SMINK J. (NED)
29	SMINK Jesper (NED)	25	MATHIEU A. (FRA)
30	MATHIEU Alexis (FRA)	26	DIAO Abderahmane (SEN)
31	DIAO Abderahmane (SEN)	27	GOMES M. (BRA)
32	GOMES Marcelo (BRA)	28	GOMES M. (BRA)
			00 s0/00 s0 [00:25]
			00 s0/02 s0 [02:27]

**POOL D**

33	TOTH Krisztian (HUN)	25	TOTH K. (HUN)
34	CRET Alex (ROU)	26	MOSAKHLISHVILI T. (ESP)
35	MOSAKHLISHVILI Tristani (ESP)	27	MADZHIDOV Dzhakhongir (TJK)
36	MADZHIDOV Dzhakhongir (TJK)	28	GUNCHENKO Stanislav (UKR)
37	GUNCHENKO Stanislav (UKR)	29	RANDL Milan (SVK)
38	RANDL Milan (SVK)	30	MAISURADZE Luka (GEO)
39	MAISURADZE Luka (GEO)	31	SAGAIPOV Caramnob (LBN)
40	SAGAIPOV Caramnob (LBN)	32	KUUSIK Mattias (EST)
41	KUUSIK Mattias (EST)	33	ISHENBAEV Anarbek (KGZ)
42	ISHENBAEV Anarbek (KGZ)	34	ISHENBAEV A. (KGZ)
43	GANTULGA Altanbagana (MGL)	35	GANTULGA A. (MGL)
44	HAZEM Ali (EGY)	36	GANTULGA A. (MGL)
			10 s0/00 s3 [05:49]

**REPECHAGE**

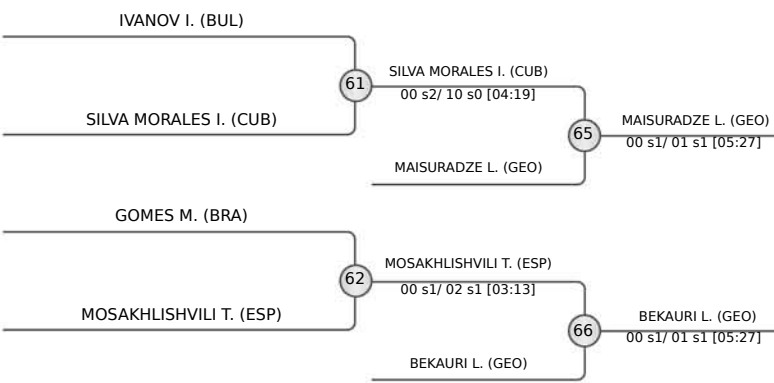

FINAL RESULTS		
1.	BOBONOV Davlat	UZB
2.	PARLATI Christian	ITA
3.	MAISURADZE Luka	GEO
4.	BEKAURI Lasha	GEO
5.	SILVA MORALES Ivan Felipe	CUB
6.	MOSAKHLISHVILI Tristani	ESP
7.	GOMES Marcelo	BRA
8.	IVANOV Ivaylo	BUL





# Tashkent World Championships Senior 2022

## Uzbekistan, Tashkent, 6-12 Oct 2022

# -48 kg

Seniors (38)

**POOL A**

1	BOUKLI Shirine	FRA
2	SORIANO Estefania	DOM
3	SALENS Ellen	BEL
4	LIMA Amanda	BRA
5	ABUZHAKYNOVA Abiba	KAZ
6	NIKOLIC Milica	SRB
7	POP Alexandra	ROU
8	PRADO Giovanna	USA
9	BAVUUDORJ Baasankhuu	MGL

1	BOUKLI S. (FRA)	33	BOUKLI S. (FRA)	
2	SALENS E. (BEL)	00 s2/ 01 s0 [04:00]	10 s0/ 00 s0 [00:52]	
3	LIMA A. (BRA)	34	ABUZHAKYNOVA A. (KAZ)	
4	ABUZHAKYNOVA A. (KAZ)	01 s1/ 02 s1 [04:52]	49	ABUZHAKYNOVA A. (KAZ)
5	NIKOLIC M. (SRB)	35	NIKOLIC M. (SRB)	
6	POP A. (ROU)	10 s0/ 00 s3 [03:31]	50	NIKOLIC M. (SRB)
7	PRADO G. (USA)	36	BAVUUDORJ B. (MGL)	
8	BAVUUDORJ B. (MGL)	00 s3/ 01 s2 [04:00]	57	ABUZHAKYNOVA A. (KAZ)

**POOL B**

9	RISHONY Shira	ISR
10	SCUTTO Assunta	ITA
11	AZAK Merve	TUR
12	KURBONOVA Khalimajon	UZB
13	TSUNODA Natsumi	JPN
14	MORAND Priscilla	MRI
15	LIN Chen-Hao	TPE
16	GUO Zongying	CHN
17	BEDIOUI Oumaima	TUN
18	MARTINEZ ABELENDA Laura	ESP

9	RISHONY S. (ISR)	37	SCUTTO A. (ITA)	
10	SCUTTO A. (ITA)	00 s0/ 10 s0 [01:46]	51	SCUTTO A. (ITA)
11	AZAK M. (TUR)	38	KURBONOVA K. (UZB)	
12	KURBONOVA K. (UZB)	00 s3/ 10 s1 [06:32]	52	TSUNODA N. (JPN)
13	TSUNODA N. (JPN)	39	TSUNODA N. (JPN)	
14	LIN C. (TPE)	00 s0/ 10 s1 [02:08]	40	MARTINEZ ABELENDA L. (ESP)
15	GUO Z. (CHN)	11 s0/ 00 s0 [01:23]	58	TSUNODA N. (JPN)
16	MARTINEZ ABELENDA L. (ESP)	00 s3/ 10 s1 [05:18]	59	MENZ K. (GER)
17	MARTINEZ ABELENDA L. (ESP)	00 s2/ 01 s1 [04:16]	60	FIGUEROA J. (ESP)

**POOL C**

17	COSTA Catarina	POR
18	MUNEME Jennie	MOZ
19	MENZ Katharina	GER
20	TANZER Katharina	AUT
21	MILANI Francesca	ITA
22	GANBAATAR Narantsetseg	MGL
23	LABORDE Maria Celia	USA
24	VARGAS LEY Mary Dee	CHI
25	HOJAGELDIYEVA Aksoltan	TKM

17	COSTA C. (POR)	41	MENZ K. (GER)	
18	MENZ K. (GER)	00 s0/ 10 s0 [00:00]	53	MENZ K. (GER)
19	TANZER K. (AUT)	42	MILANI F. (ITA)	
20	MILANI F. (ITA)	00 s0/ 10 s0 [00:50]	54	VARGAS LEY M. (CHI)
21	GANBAATAR N. (MGL)	43	LABORDE M. (USA)	
22	LABORDE M. (USA)	00 s0/ 10 s0 [00:26]	55	TONAKI F. (JPN)
23	VARGAS LEY M. (CHI)	44	VARGAS LEY M. (CHI)	
24	HOJAGELDIYEVA A. (TKM)	45	LIU T. (CHN)	

**POOL D**

25	TONAKI Funa	JPN
26	LIU Ting	CHN
27	STOJADINOV Andrea	SRB
28	MALCA Tamar	ISR
29	STANGAR Marusa	SLO
30	BEDER Tugce	TUR
31	FIGUEROA Julia	ESP
32	ALIYEVA Leyla	AZE
33	LEE Hyekyeong	KOR
34	KANYAMUNEZA Signoline	BDI

25	TONAKI F. (JPN)	45	TONAKI F. (JPN)	
26	LIU T. (CHN)	10 s2/ 00 s3 [06:43]	46	BEDER T. (TUR)
27	STOJADINOV A. (SRB)	10 s1/ 00 s1 [00:37]	47	FIGUEROA J. (ESP)
28	MALCA T. (ISR)	00 s1/ 01 s1 [04:00]	48	LEE H. (KOR)
29	STANGAR M. (SLO)	00 s1/ 01 s1 [04:00]	49	ABUZHAKYNOVA A. (KAZ)
30	BEDER T. (TUR)	00 s1/ 01 s1 [04:00]	50	FIGUEROA J. (ESP)
31	FIGUEROA J. (ESP)	01 s0/ 00 s0 [04:00]	51	SCUTTO A. (ITA)
32	ALIYEVA L. (AZE)	01 s0/ 00 s0 [04:00]	52	TSUNODA N. (JPN)
33	LEE H. (KOR)	10 s1/ 00 s1 [01:43]	53	MENZ K. (GER)
34	KANYAMUNEZA S. (BDI)	10 s1/ 00 s1 [01:43]	54	VARGAS LEY M. (CHI)

**REPECHAGE**

61	SCUTTO A. (ITA)	00 s0/ 10 s0 [00:00]	65	SCUTTO A. (ITA)	11 s2/ 00 s0 [03:17]
62	VARGAS LEY M. (CHI)	10 s0/ 00 s0 [00:00]	66	ABUZHAKYNOVA A. (KAZ)	11 s2/ 00 s0 [03:17]
63	TSUNODA N. (JPN)	00 s0/ 10 s1 [01:49]	64	MENZ K. (GER)	01 s1/ 00 s1 [04:00]
64	MENZ K. (GER)	01 s0/ 00 s1 [04:00]	65	SCUTTO A. (ITA)	11 s2/ 00 s0 [03:17]
65	FIGUEROA J. (ESP)	00 s1/ 10 s1 [05:33]	66	ABUZHAKYNOVA A. (KAZ)	11 s2/ 00 s0 [03:17]
66	ABUZHAKYNOVA A. (KAZ)	11 s2/ 00 s0 [03:17]	67	TSUNODA N. (JPN)	02 s0/ 00 s0 [02:16]

FINAL RESULTS		
1.	TSUNODA Natsumi	JPN
2.	MENZ Katharina	GER
3.	SCUTTO Assunta	ITA
4.	ABUZHAKYNOVA Abiba	KAZ
5.	FIGUEROA Julia	ESP
6.	VARGAS LEY Mary Dee	CHI
7.	TONAKI Funa	JPN
8.	NIKOLIC Milica	SRB





# Tashkent World Championships Senior 2022

## Uzbekistan, Tashkent, 6-12 Oct 2022

# -63 kg

## Seniors (41)

**POOL A**

1	RENSHALL Lucy	GBR
2	CABANA PEREZ Cristina	ESP
3	BELKADI Amina	ALG
4	BOLD Gankhaich	MGL
5	PRIMO Kerem	ISR
6	KUYULOVA Esmigul	KAZ
7	HAECKER Katharina	AUS
8	ANTIPINA Anastasiia	UKR
9	<b>HORIKAWA Megumi</b>	<b>JPN</b>
10	D ISANTO Nicolle	ITA

1	RENSHALL L. (GBR)	33	RENSHALL L. (GBR)
2	BELKADI A. (ALG)	00 s1/ 01 s2 [04:00]	10 s0/ 00 s3 [04:52]
3	PRIMO K. (ISR)	00 s3/ 10 s1 [05:14]	10 s1/ 00 s3 [04:52]
4	KUYULOVA E. (KAZ)	10 s0/ 00 s3 [02:40]	10 s1/ 00 s3 [04:52]
5	HAECKER K. (AUS)	35	HAECKER K. (AUS)
6	ANTIPINA A. (UKR)	10 s0/ 00 s0 [00:52]	10 s1/ 00 s3 [04:52]
7	HORIKAWA M. (JPN)	36	HORIKAWA M. (JPN)
8	D ISANTO N. (ITA)	10 s0/ 00 s1 [01:24]	10 s1/ 00 s3 [04:52]

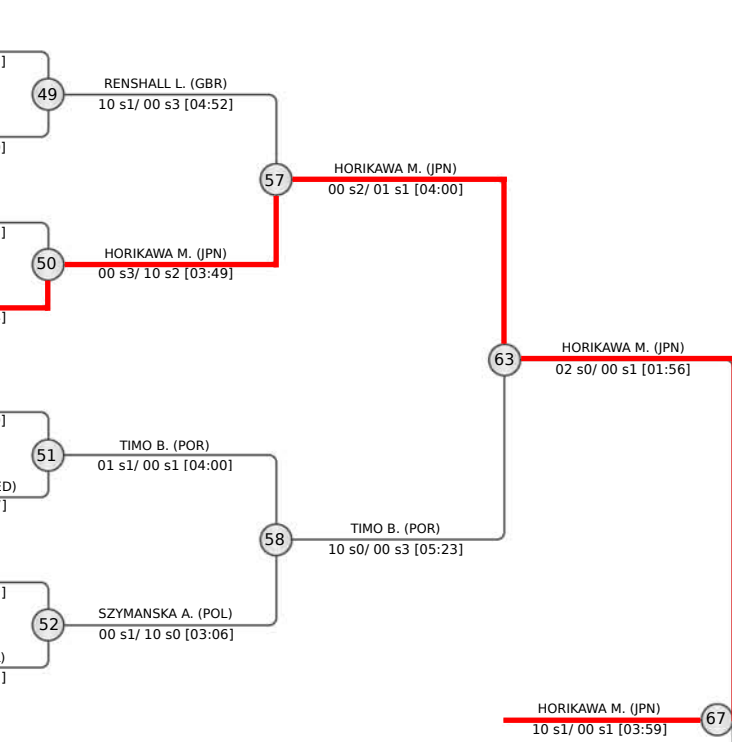

**POOL B**

9	LESKI Andreja	SLO
10	TIMO Barbara	POR
11	OBRADOVIC Anja	SRB
12	VAN DEN BERG Geke	NED
13	FAYE Anna Siga	SEN
14	OZBAS Szofi	HUN
15	LEE Juyeon	KOR
16	SZYMANSKA Angelika	POL
17	DELGADO FRANCES Carolina	CPV
18	GOLDEN Sara	USA

9	LESKI A. (SLO)	37	TIMO B. (POR)
10	TIMO B. (POR)	00 s1/ 01 s0 [04:19]	11 s1/ 00 s2 [03:46]
11	VAN DEN BERG G. (NED)	38	VAN DEN BERG G. (NED)
12	FAYE A. (SEN)	11 s0/ 00 s0 [00:37]	11 s0/ 00 s0 [00:37]
13	OZBAS S. (HUN)	39	OZBAS S. (HUN)
14	LEE J. (KOR)	10 s1/ 00 s1 [02:55]	10 s1/ 00 s1 [02:55]
15	SZYMANSKA A. (POL)	40	SZYMANSKA A. (POL)
16	GOLDEN S. (USA)	00 s2/ 10 s2 [07:45]	10 s0/ 00 s0 [00:11]

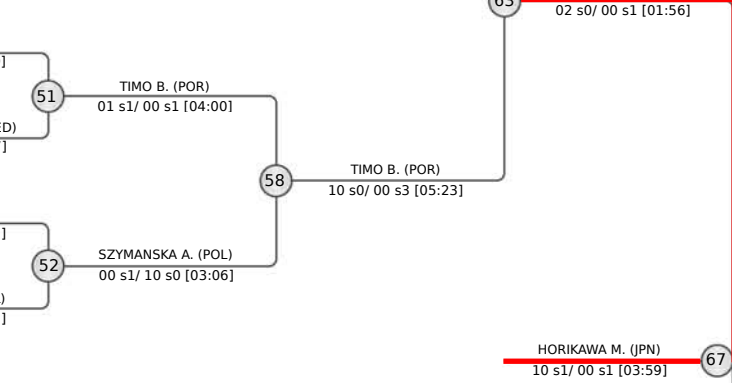

**POOL C**

17	BEAUCHEMIN-PINARD Catherine	CAN
18	ETOUA BLOCK Audrey Jeannette	CMR
19	FAZLIU Laura	KOS
20	KIM Jijeong	KOR
21	OBERAN Iva	CRO
22	SHARIR Gili	ISR
23	PADILLA GUERRERO Sarai	ESP
24	DEL TORO CARVAJAL Maylin	CUB
25	BAZYNSKI Nadja	GER
26	ZACHOVA Renata	CZE
27	DASHKINOVA Zulhumar	TKM

17	BEAUCHEMIN-PINARD C. (CAN)	41	BEAUCHEMIN-PINARD C. (CAN)
18	ETOUA BLOCK A. (CMR)	10 s2/ 00 s0 [02:25]	10 s0/ 00 s0 [00:53]
19	KIM J. (KOR)	42	OBERAN I. (CRO)
20	OBERAN I. (CRO)	00 s1/ 02 s1 [02:14]	10 s0/ 00 s0 [01:08]
21	SHARIR G. (ISR)	43	SHARIR G. (ISR)
22	PADILLA GUERRERO S. (ESP)	10 s2/ 00 s3 [05:51]	10 s2/ 00 s3 [05:51]
23	DEL TORO CARVAJAL M. (CUB)	44	ZACHOVA R. (CZE)
24	BAZYNSKI N. (GER)	00 s2/ 10 s2 [08:09]	00 s0/ 01 s0 [04:00]
25	ZACHOVA R. (CZE)	02 s0/ 00 s0 [00:35]	00 s0/ 01 s0 [04:00]
26	DASHKINOVA Z. (TKM)	45	QUADROS K. (BRA)
27	QUADROS K. (BRA)	10 s2/ 00 s2 [02:34]	10 s2/ 00 s2 [02:34]
28	TANG J. (CHN)	46	IVANESCU F. (ROU)
29	SANCHEZ Ariela	10 s2/ 00 s0 [03:00]	00 s3/ 10 s2 [05:23]
30	MARTIN Hannah	47	VERMEER S. (NED)
31	IVANESCU Florentina	00 s3/ 10 s2 [05:23]	10 s0/ 00 s1 [01:23]
32	VERMEER Sanne	48	DEKETER M. (FRA)
33	VERMEER S. (NED)	10 s0/ 00 s1 [01:23]	00 s1/ 10 s0 [02:06]
34	NARYNOVA Moldir	49	DEKETER M. (FRA)
35	NARYNOVA M. (KAZ)	10 s0/ 00 s1 [01:23]	00 s0/ 11 s0 [02:40]
36	ISOKOVA Sevinch	50	DEKETER M. (FRA)
37	ISAEVA Azhar	10 s1/ 00 s3 [05:24]	00 s1/ 10 s0 [03:27]
38	DEKETER Manon	51	DEKETER M. (FRA)
39	DEKETER M. (FRA)	00 s1/ 10 s0 [01:13]	00 s1/ 10 s0 [03:27]

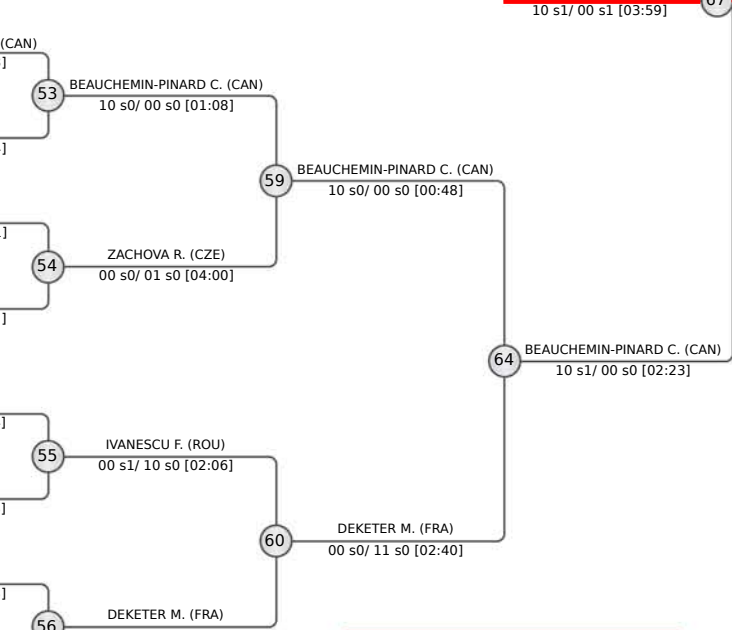

**POOL D**

25	QUADROS Ketleyn	BRA
26	TANG Jing	CHN
27	SANCHEZ Ariela	DOM
28	MARTIN Hannah	USA
29	IVANESCU Florentina	ROU
30	VERMEER Sanne	NED
31	NARYNOVA Moldir	KAZ
32	ISOKOVA Sevinch	UZB
33	ISAEVA Azhar	KGZ
34	DEKETER Manon	FRA

25	QUADROS K. (BRA)	45	QUADROS K. (BRA)
26	TANG J. (CHN)	10 s2/ 00 s0 [03:00]	10 s2/ 00 s2 [02:34]
27	MARTIN H. (USA)	46	IVANESCU F. (ROU)
28	IVANESCU F. (ROU)	00 s3/ 10 s2 [05:23]	00 s3/ 10 s2 [05:23]
29	VERMEER S. (NED)	47	VERMEER S. (NED)
30	NARYNOVA M. (KAZ)	10 s0/ 00 s1 [01:23]	10 s0/ 00 s1 [01:23]
31	ISOKOVA S. (UZB)	48	DEKETER M. (FRA)
32	ISAEVA A. (KGZ)	10 s1/ 00 s3 [05:24]	00 s1/ 10 s0 [01:13]
33	DEKETER M. (FRA)	49	DEKETER M. (FRA)
34	DEKETER M. (FRA)	00 s1/ 10 s0 [01:13]	00 s1/ 10 s0 [03:27]

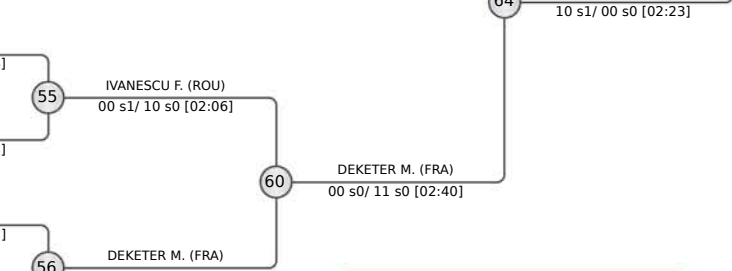

### FINAL RESULTS

- HORIKAWA Megumi** JPN
- BEAUCHEMIN-PINARD Catherine CAN
- DEKETER Manon FRA
- TIMO Barbara POR
- SZYMANSKA Angelika POL
- IVANESCU Florentina ROU
- RENSHALL Lucy GBR
- ZACHOVA Renata CZE

**REPECHAGE**

