



Qingdao Grand Prix 2026

People's Republic of China, Qingdao, 26-28 Jun 2026

-60 kg

Seniors (38)

POOL A

| | | | | | | |
|------------------------|-----|---|-------------------------|----|------------------------|------------------------|
| AGHAYEV Balabay | AZE | 1 | AGHAYEV B. (AZE) | 33 | AGHAYEV B. (AZE) | 010 s0/ 000 s1 [04:33] |
| LESIUK Artem | UKR | 2 | LESIUK A. (UKR) | 33 | AGHAYEV B. (AZE) | 010 s0/ 000 s1 [04:33] |
| SUN Jiahao | CHN | 3 | SUN J. (CHN) | 34 | SMETOV Y. (KAZ) | 000 s1/ 020 s1 [02:07] |
| SMETOV Yeldos | KAZ | 4 | SMETOV Y. (KAZ) | 34 | SMETOV Y. (KAZ) | 000 s1/ 020 s1 [02:07] |
| JEAN Enzo | FRA | 5 | JEAN E. (FRA) | 35 | JEAN E. (FRA) | 100 s1/ 000 s1 [02:12] |
| NAERT Olivier | BEL | 6 | NAERT O. (BEL) | 35 | JEAN E. (FRA) | 100 s1/ 000 s1 [02:12] |
| GURBANBERDIYEV Ygtyyar | TKM | 7 | ALAOUI CHERIFI A. (MAR) | 36 | KANATBEK UULU T. (KGZ) | 000 s0/ 011 s0 [04:00] |
| ALAOUI CHERIFI Ahmed | MAR | 7 | ALAOUI CHERIFI A. (MAR) | 36 | KANATBEK UULU T. (KGZ) | 000 s0/ 011 s0 [04:00] |
| KANATBEK UULU Tugol | KGZ | 8 | KANATBEK UULU T. (KGZ) | 36 | KANATBEK UULU T. (KGZ) | 000 s0/ 011 s0 [04:00] |

POOL B

| | | | | | | |
|------------------------|-----|----|------------------------|----|---------------------|------------------------|
| ASHPIZ Izhak | ISR | 9 | ASHPIZ I. (ISR) | 37 | TUVSHINTUR T. (MGL) | 000 s0/ 100 s0 [00:14] |
| RI Nam Yong | PRK | 10 | TUVSHINTUR T. (MGL) | 37 | TUVSHINTUR T. (MGL) | 000 s0/ 100 s0 [00:14] |
| TUVSHINTUR Tumenjargal | MGL | 10 | TUVSHINTUR T. (MGL) | 37 | TUVSHINTUR T. (MGL) | 000 s0/ 100 s0 [00:14] |
| KUCHKAROV Samariddin | UZB | 11 | KUCHKAROV S. (UZB) | 38 | KUCHKAROV S. (UZB) | 010 s2/ 000 s2 [04:17] |
| JIN Feng | CHN | 12 | JIN F. (CHN) | 38 | KUCHKAROV S. (UZB) | 010 s2/ 000 s2 [04:17] |
| AUGUSTO Michel | BRA | 13 | AUGUSTO M. (BRA) | 39 | AUGUSTO M. (BRA) | 001 s0/ 000 s0 [04:00] |
| BARROSO LOPEZ Luis | ESP | 14 | BARROSO LOPEZ L. (ESP) | 39 | AUGUSTO M. (BRA) | 001 s0/ 000 s0 [04:00] |
| HEYDER Maximilian | GER | 15 | HEYDER M. (GER) | 40 | AYRE C. (GBR) | 000 s0/ 100 s1 [02:15] |
| SAAEV Iznaur | RUS | 15 | HEYDER M. (GER) | 40 | AYRE C. (GBR) | 000 s0/ 100 s1 [02:15] |
| AYRE Charlie | GBR | 16 | AYRE C. (GBR) | 40 | AYRE C. (GBR) | 000 s0/ 100 s1 [02:15] |

POOL C

| | | | | | | |
|---------------------|-----|----|--------------------|----|------------------|------------------------|
| YUSIFOV Ahmad | AZE | 17 | YUSIFOV A. (AZE) | 41 | YUSIFOV A. (AZE) | 100 s0/ 000 s1 [01:57] |
| KHALMATOV Dilshot | UKR | 18 | KHALMATOV D. (UKR) | 41 | YUSIFOV A. (AZE) | 100 s0/ 000 s1 [01:57] |
| YRYSBEKOV Khanbolot | KGZ | 19 | MA Y. (CHN) | 42 | MA Y. (CHN) | 000 s1/ 010 s1 [04:00] |
| MA Yulin | CHN | 19 | MA Y. (CHN) | 42 | MA Y. (CHN) | 000 s1/ 010 s1 [04:00] |
| SINGH Harsh | IND | 20 | SINGH H. (IND) | 42 | MA Y. (CHN) | 000 s1/ 010 s1 [04:00] |
| KONDO Hayato | JPN | 21 | KONDO H. (JPN) | 43 | KONDO H. (JPN) | 011 s0/ 000 s2 [04:00] |
| AJENA Omran | SYR | 22 | AJENA O. (SYR) | 43 | KONDO H. (JPN) | 011 s0/ 000 s2 [04:00] |
| RAMAZANOV Mekan | TKM | 23 | RAMAZANOV M. (TKM) | 44 | AN S. (PRK) | 000 s0/ 001 s0 [04:00] |
| AN Sin Hyok | PRK | 24 | AN S. (PRK) | 44 | AN S. (PRK) | 000 s0/ 001 s0 [04:00] |

POOL D

| | | | | | | |
|--------------------------------------|-----|----|----------------------|----|---------------------|------------------------|
| BLIEV Ayub | RUS | 25 | BLIEV A. (RUS) | 45 | BLIEV A. (RUS) | 110 s0/ 000 s0 [02:13] |
| SUN Jiaxu | CHN | 26 | SUN J. (CHN) | 45 | BLIEV A. (RUS) | 110 s0/ 000 s0 [02:13] |
| MURILLO MARTINEZ DE LIZARRONDO Asier | ESP | 27 | ISMAEL D. (BRA) | 46 | BOTUROV B. (UZB) | 000 s0/ 100 s0 [02:08] |
| ISMAEL Diego | BRA | 27 | ISMAEL D. (BRA) | 46 | BOTUROV B. (UZB) | 000 s0/ 100 s0 [02:08] |
| BOTUROV Bakhrom | UZB | 28 | BOTUROV B. (UZB) | 46 | BOTUROV B. (UZB) | 000 s0/ 100 s0 [02:08] |
| BYAMBASUREN Sukhbat | MGL | 29 | BYAMBASUREN S. (MGL) | 47 | STARKEL D. (SLO) | 002 s1/ 101 s1 [04:00] |
| STARKEL David | SLO | 30 | STARKEL D. (SLO) | 47 | STARKEL D. (SLO) | 002 s1/ 101 s1 [04:00] |
| KATZ Joshua | AUS | 31 | KATZ J. (AUS) | 48 | ORYNBASSAR T. (KAZ) | 000 s0/ 010 s2 [04:00] |
| IGNASIAK Ksawery | POL | 31 | KATZ J. (AUS) | 48 | ORYNBASSAR T. (KAZ) | 000 s0/ 010 s2 [04:00] |
| ORYNBASSAR Talgat | KAZ | 32 | ORYNBASSAR T. (KAZ) | 48 | ORYNBASSAR T. (KAZ) | 000 s0/ 010 s2 [04:00] |

REPECHAGE

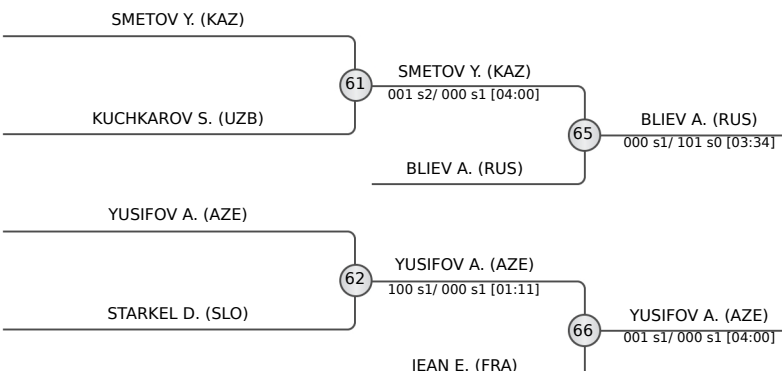

| FINAL RESULTS | |
|---------------|--------------------------|
| 1. | KONDO Hayato JPN |
| 2. | AYRE Charlie GBR |
| 3. | BLIEV Ayub RUS |
| 4. | YUSIFOV Ahmad AZE |
| 5. | SMETOV Yeldos KAZ |
| 6. | JEAN Enzo FRA |
| 7. | KUCHKAROV Samariddin UZB |
| 8. | STARKEL David SLO |





Qingdao Grand Prix 2026

People's Republic of China, Qingdao, 26-28 Jun 2026

-66 kg

Seniors (34)

POOL A

| | | |
|---|------------------------|-----|
| 1 | ABE Hifumi | JPN |
| 2 | DE LUCA Alessio | ITA |
| 3 | CHRISTODOULIDES Petros | CYP |
| 4 | BABATOV Islam | RUS |
| 5 | YONDONPERENLEI Baskhuu | MGL |
| 6 | WANG Jiangfeng | CHN |
| 7 | PONGRACZ Bence | HUN |
| 8 | MUCIK Hilmi | TUR |

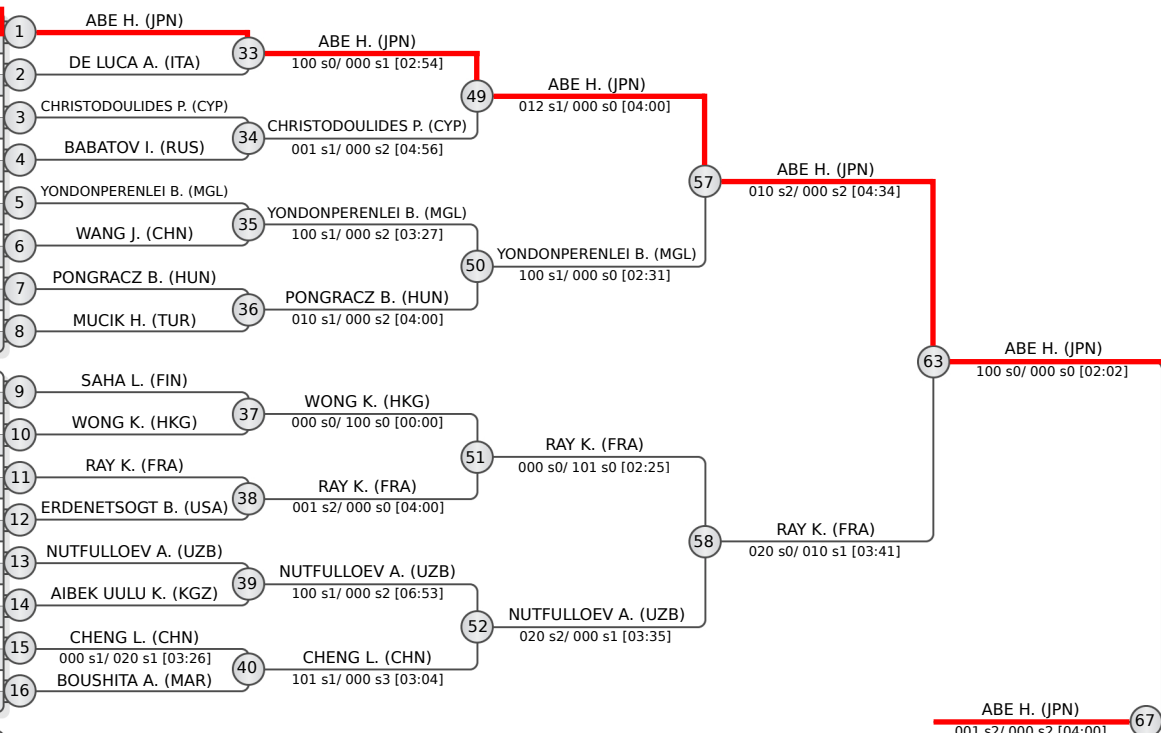

POOL B

| | | |
|----|------------------------|-----|
| 9 | SAHA Luukas | FIN |
| 10 | WONG Ka Ki | HKG |
| 11 | RAY Kelvin | FRA |
| 12 | ERDENETSOGT Bilegt | USA |
| 13 | NUTFULLOEV Abdurakhim | UZB |
| 14 | AIBEK UULU Kubanychbek | KGZ |
| 15 | MAMMADOV Tofiq | AZE |
| 16 | CHENG Lin | CHN |
| 16 | BOUSHITA Abderrahmane | MAR |

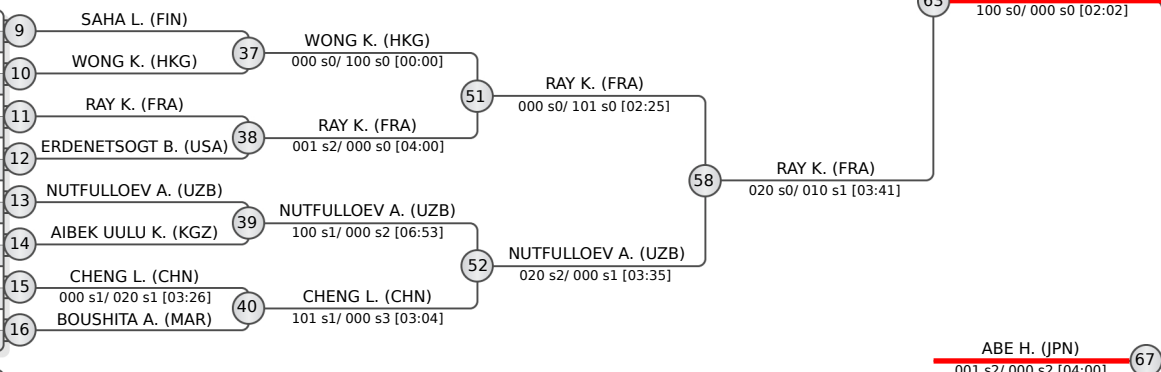

POOL C

| | | |
|----|--------------------|-----|
| 17 | PASHAYEV Ruslan | AZE |
| 18 | YILDIZ Salih | TUR |
| 18 | XUE Ziyang | CHN |
| 19 | OROZMAMATOV Adis | KGZ |
| 20 | RENARD Alexis | FRA |
| 21 | KYRGYZBAYEV Gusman | KAZ |
| 22 | TUMURKHUU Turbold | MGL |
| 23 | NURKOVIC Jusuf | MNE |
| 24 | AHN Hyunwoo | KOR |

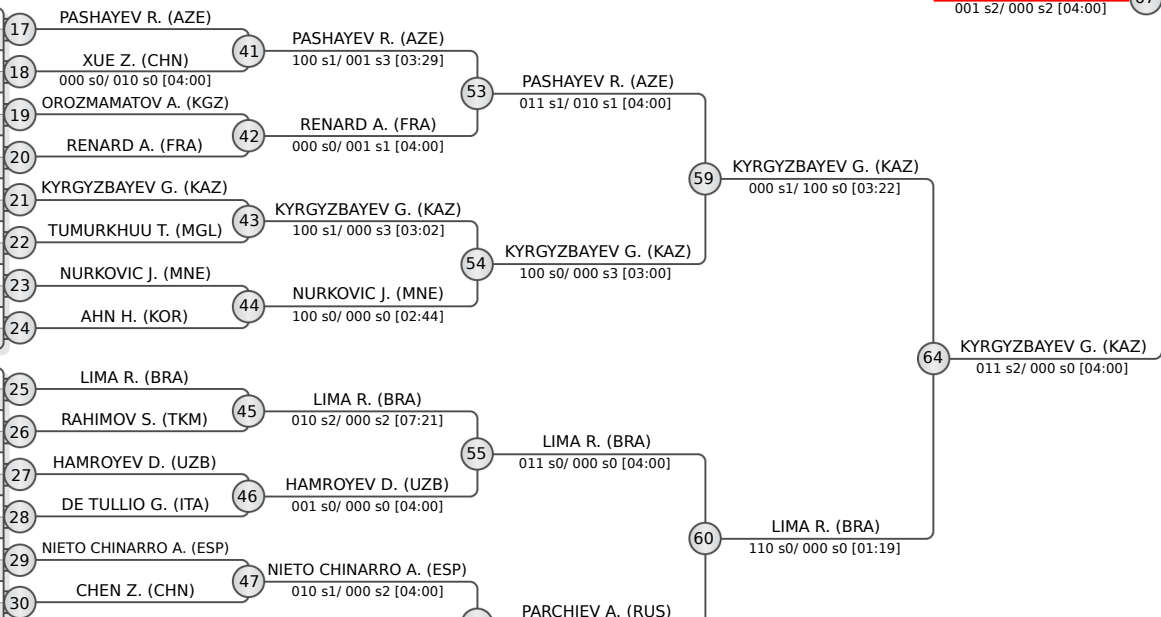

POOL D

| | | |
|----|-----------------------|-----|
| 25 | LIMA Ronald | BRA |
| 26 | RAHIMOV Serdar | TKM |
| 27 | HAMROYEV Dilshodbek | UZB |
| 28 | DE TULLIO Giuseppe | ITA |
| 29 | NIETO CHINARRO Adrian | ESP |
| 30 | CHEN Zhengyang | CHN |
| 31 | BOECKER Florian | GER |
| 32 | PARCHIEV Abdullakh | RUS |

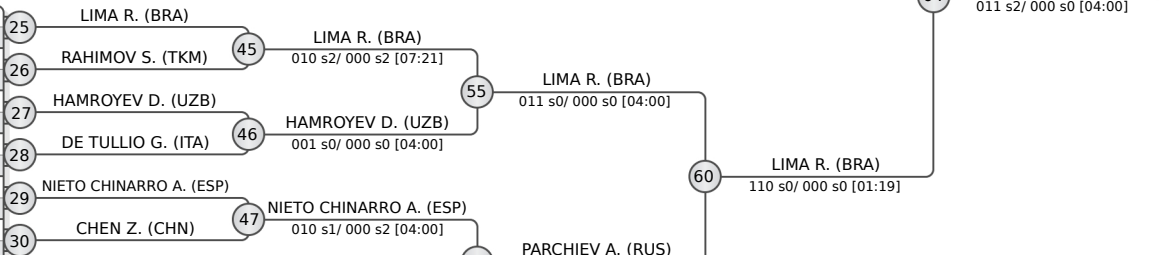

REPECHAGE

| | |
|----|-------------------------|
| 61 | YONDONPERENLEI B. (MGL) |
| 62 | PASHAYEV R. (AZE) |
| 65 | LIMA R. (BRA) |
| 66 | RAY K. (FRA) |

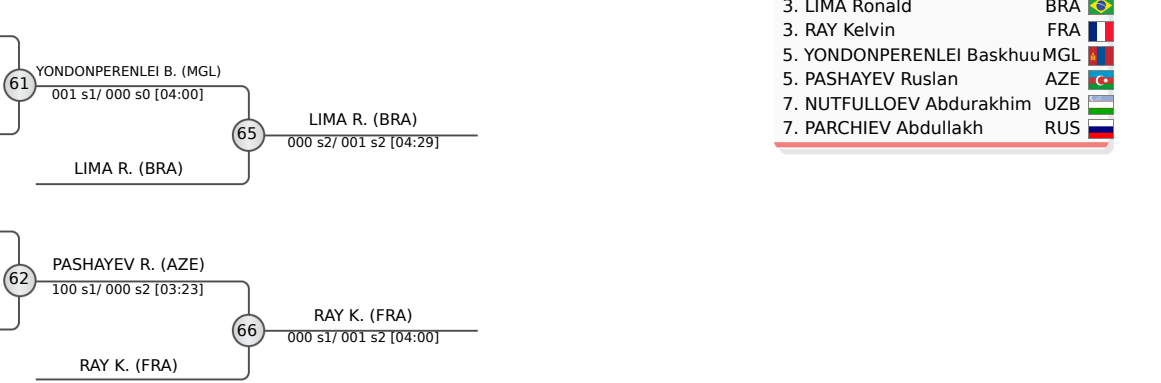

FINAL RESULTS

| | | |
|----|------------------------|-----|
| 1. | ABE Hifumi | JPN |
| 2. | KYRGYZBAYEV Gusman | KAZ |
| 3. | LIMA Ronald | BRA |
| 3. | RAY Kelvin | FRA |
| 5. | YONDONPERENLEI Baskhuu | MGL |
| 5. | PASHAYEV Ruslan | AZE |
| 7. | NUTFULLOEV Abdurakhim | UZB |
| 7. | PARCHIEV Abdullakh | RUS |





Qingdao Grand Prix 2026

People's Republic of China, Qingdao, 26-28 Jun 2026

-90 kg

Seniors (36)

POOL A

| | | | | | |
|---|-----------------------------|-----|---|---------------------|----|
| 1 | FATYEV Murad | AZE | 1 | FATYEV M. (AZE) | |
| 2 | LI Shuo | CHN | 2 | LI S. (CHN) | 33 |
| 3 | KARAPETYAN David | RUS | 3 | KARAPETYAN D. (RUS) | |
| 4 | FALCONE Tiziano | ITA | 4 | FALCONE T. (ITA) | 34 |
| 5 | MURTOZOEV Nurbek | UZB | 5 | MURTOZOEV N. (UZB) | |
| 6 | SANTAMARIA RODRIGUEZ Aharon | ESP | 6 | SIVAN R. (ISR) | 35 |
| 7 | SIVAN Roy | ISR | 7 | KHALIL A. (EGY) | |
| 8 | KHALIL Ammar | EGY | 8 | NERPEL G. (HUN) | 36 |
| | NERPEL Gergely | HUN | | | |

POOL B

| | | | | | |
|----|---------------------|-----|----|----------------------|----|
| 9 | SCHIMIDT Guilherme | BRA | 9 | SCHIMIDT G. (BRA) | |
| 10 | TRIPPEL Eduard | GER | 10 | TRIPPEL E. (GER) | 37 |
| 11 | VISAN Vlad | ROU | 11 | ARAOV A. (KAZ) | |
| 12 | ARAOV Aidar | KAZ | 12 | SCHARFETTER T. (AUT) | 38 |
| 13 | SCHARFETTER Thomas | AUT | 13 | FRONCKOWIAK M. (BRA) | |
| 14 | FRONCKOWIAK Marcelo | BRA | 14 | JAYNE J. (USA) | 39 |
| 15 | JAYNE John | USA | 15 | HALMUMINOV O. (TKM) | |
| 16 | HALMUMINOV Omuruzak | TKM | 16 | HAN Q. (CHN) | 40 |
| | HAN Qi | CHN | | | |

POOL C

| | | | | | |
|----|-----------------|-----|----|--------------------|----|
| 17 | TAJIMA Goki | JPN | 17 | TAJIMA G. (JPN) | |
| 18 | KRYLOV Daniil | KAZ | 18 | KRYLOV D. (KAZ) | 41 |
| 19 | MARCZAK Derek | POL | 19 | MARCZAK D. (POL) | |
| 20 | GLEESON Bearach | IRL | 20 | GLEESON B. (IRL) | 42 |
| 21 | BARTO Alex | SVK | 21 | BARTO A. (SVK) | |
| 22 | CRET Alex | ROU | 22 | BU H. (CHN) | 43 |
| 23 | BU Hebilige | CHN | 23 | VARAPAYEU Y. (BLR) | |
| 24 | VARAPAYEU Yahor | BLR | 24 | KOTSOEV A. (AZE) | 44 |
| | KOTSOEV Aslan | AZE | | | |

POOL D

| | | | | | |
|----|--------------------------|-----|----|---------------------|----|
| 25 | RUTOVIC Boris | SRB | 25 | RUTOVIC B. (SRB) | |
| 26 | KUDIEV Kurban | RUS | 26 | KUDIEV K. (RUS) | 45 |
| 27 | FRIDMAN ZILBERSTEIN Reem | ISR | 27 | MOORHEAD L. (GBR) | |
| 28 | MOORHEAD Lachlan | GBR | 28 | KANATBEKOV E. (KGZ) | 46 |
| 29 | KANATBEKOV Erzhan | KGZ | 29 | KALJULAI K. (EST) | |
| 30 | KALJULAI Klen Kristofer | EST | 30 | ABDELSAMEA A. (EGY) | 47 |
| 31 | ABDELSAMEA Abdalla | EGY | 31 | BOBONOV D. (UZB) | |
| 32 | BOBONOV Davlat | UZB | 32 | QINARITU Q. (CHN) | 48 |
| | QINARITU Qinaritu | CHN | | | |

REPECHAGE

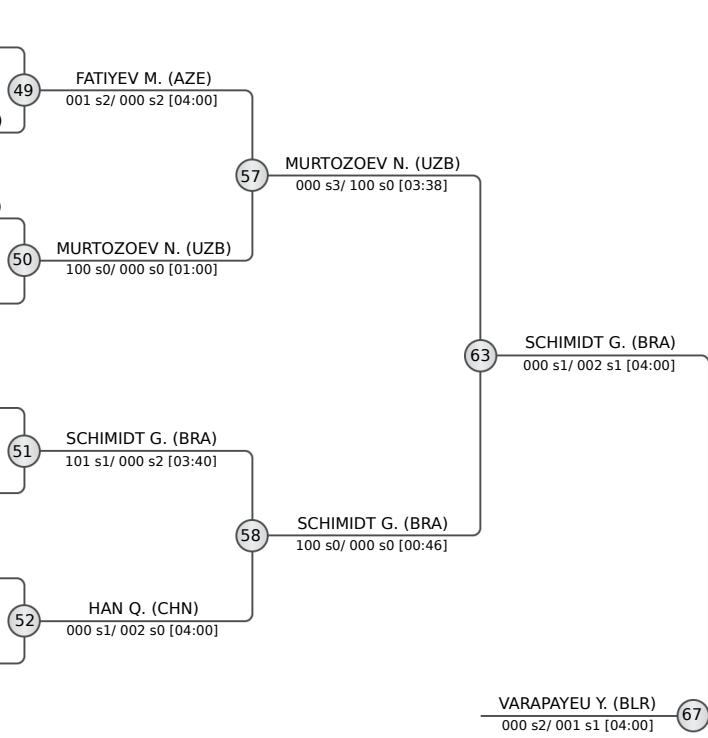
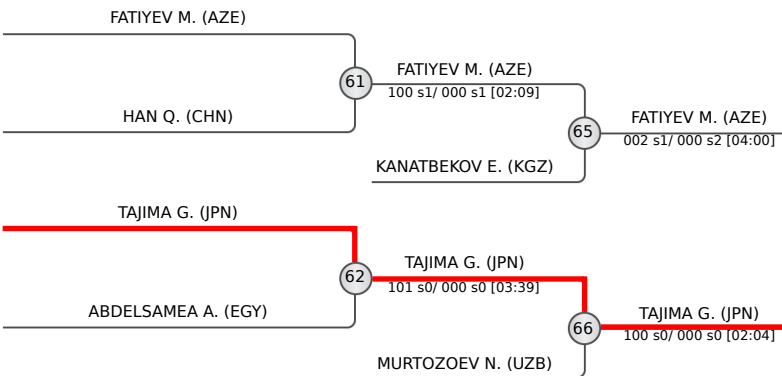

| FINAL RESULTS | |
|---------------|------------------------|
| 1. | VARAPAYEU Yahor BLR |
| 2. | SCHIMIDT Guilherme BRA |
| 3. | FATYEV Murad AZE |
| 3. | TAJIMA Goki JPN |
| 5. | KANATBEKOV Erzhan KGZ |
| 7. | MURTOZOEV Nurbek UZB |
| 7. | HAN Qi CHN |
| 7. | ABDELSAMEA Abdalla EGY |





Qingdao Grand Prix 2026

People's Republic of China, Qingdao, 26-28 Jun 2026

-78 kg

Seniors (35)

POOL A

| | | | | |
|--------------------|-----|---|----------------------|------------------------|
| OLEK Anna Monta | GER | 1 | OLEK A. (GER) | |
| KANTSAVAYA Darya | BLR | 2 | KANTSAVAYA D. (BLR) | 33 |
| KODIROVA Barchinoy | UZB | 3 | KODIROVA B. (UZB) | 100 s2/ 000 s3 [05:30] |
| JANGELDINA Aruna | KAZ | | NGELEBEYA L. (FRA) | |
| NGELEBEYA Liz | FRA | 4 | NGELEBEYA L. (FRA) | 34 |
| WU Hongtao | CHN | 5 | WU H. (CHN) | |
| KRAPU Emma | FIN | 6 | KRAPU E. (FIN) | 35 |
| BOUSBAA DAB Nisrin | ESP | 7 | BOUSBAA DAB N. (ESP) | |
| ESPOSITO Martina | ITA | 8 | ESPOSITO M. (ITA) | 36 |

POOL B

| | | | | |
|--------------------------|-----|----|------------------------|----|
| FREITAS Beatriz | BRA | 9 | FREITAS B. (BRA) | |
| DENGG Elena | AUT | 10 | DENGG E. (AUT) | 37 |
| AILTGUIBAATAR Dulamsuren | MGL | 11 | AILTGUIBAATAR D. (MGL) | |
| KIM Juyun | KOR | 12 | KIM J. (KOR) | 38 |
| REID Emma | GBR | 13 | REID E. (GBR) | |
| SONG Yanzi | CHN | 14 | SONG Y. (CHN) | 39 |
| MICHAELIDOU Zanet | CYP | 15 | WROBLEWSKA E. (POL) | |
| WROBLEWSKA Eliza | POL | | WROBLEWSKA E. (POL) | 40 |
| KULIC Karla | CRO | 16 | KULIC K. (CRO) | 40 |

POOL C

| | | | | |
|-------------------------|-----|----|-----------------------------|----|
| LOBNIK Metka | SLO | 17 | LOBNIK M. (SLO) | |
| KUCHIMOVA Marjona | UZB | 18 | KUCHIMOVA M. (UZB) | 41 |
| RIABCHENKO Alexandra | RUS | | JANG W. (PRK) | |
| JANG Won Hui | PRK | 19 | JANG W. (PRK) | 42 |
| CAMILLO Dandara | BRA | 20 | CAMILLO D. (BRA) | 42 |
| SWAN Maria | AUS | 21 | SWAN M. (AUS) | |
| XU Huanting | CHN | 22 | XU H. (CHN) | 43 |
| SUGIMURA Mizuki | JPN | 23 | SUGIMURA M. (JPN) | 44 |
| FERNANDEZ CAMPILLO Sara | ESP | 24 | FERNANDEZ CAMPILLO S. (ESP) | 44 |

POOL D

| | | | | |
|----------------------------|-----|----|--------------------------|----|
| BOEHM Alina | GER | 25 | BOEHM A. (GER) | |
| OTGONBAYAR Khuslen | MGL | 26 | OTGONBAYAR K. (MGL) | 45 |
| MA Zhenzhao | CHN | 27 | MA Z. (CHN) | |
| GULENAY Tuana | TUR | 28 | GULENAY T. (TUR) | 46 |
| GODBOUT Coralie | CAN | 29 | GODBOUT C. (CAN) | |
| TOKAREVA Ekaterina | KAZ | 30 | TOKAREVA E. (KAZ) | 47 |
| PAVIC Petrunjela | CRO | 31 | PAVIC P. (CRO) | |
| GORGUET-VERANES Maidelines | ROU | 32 | GORGUET-VERANES M. (ROU) | 48 |

REPECHAGE

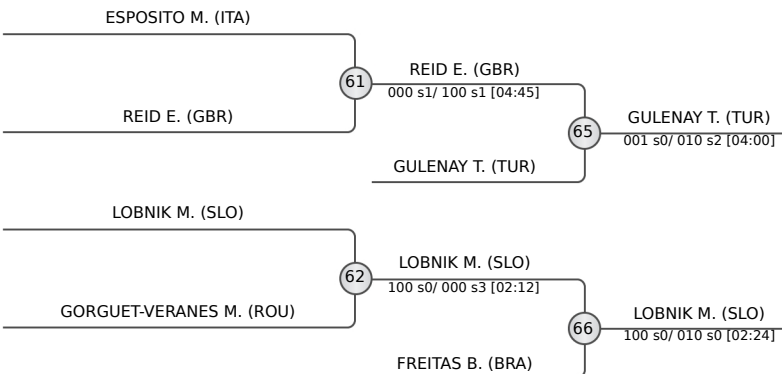

FINAL RESULTS

| | | |
|----|----------------------------|-----|
| 1. | OLEK Anna Monta | GER |
| 2. | SUGIMURA Mizuki | JPN |
| 3. | GULENAY Tuana | TUR |
| 3. | LOBNIK Metka | SLO |
| 5. | REID Emma | GBR |
| 7. | ESPOSITO Martina | ITA |
| 7. | GORGUET-VERANES Maidelines | ROU |





Qingdao Grand Prix 2026

People's Republic of China, Qingdao, 26-28 Jun 2026

+78 kg

Seniors (27)

POOL A

| | | |
|--|----------------------|-----|
| | HERSHKO Raz | ISR |
| | SOLIMAN Safa | EGY |
| | KIM Soomin | KOR |
| | STARTSEVA Elis | RUS |
| | RADIC Tina | CRO |
| | KURBANBAEVA Iriskhon | UZB |
| | TOISHIBEKOVA Aida | KAZ |

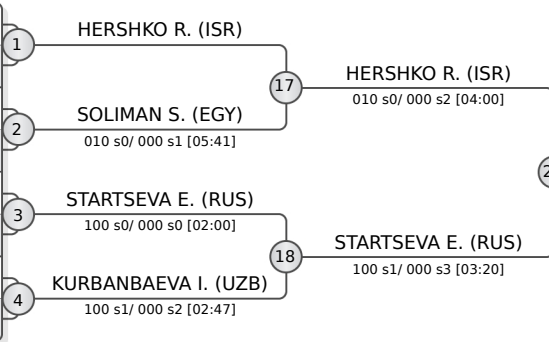

POOL B

| | | |
|--|--------------------------|-----|
| | NIU Xinran | CHN |
| | ENKHBAYAR Enkhzul | MGL |
| | SOMKHISHVILI Sophio | GEO |
| | AYIMAN Jinesinuer | CHN |
| | MINKADA-CAQUINEAU Leonie | FRA |
| | SIMONETTI Erica | ITA |

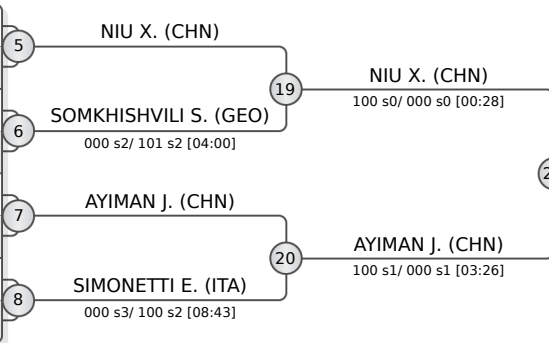

POOL C

| | | |
|--|------------------|-----|
| | FONTAINE Lea | FRA |
| | LIU Yu | CHN |
| | SU Pin-Tzu | TPE |
| | AKTAS Emma-Melis | EST |
| | SONE Akira | JPN |
| | WOOD Gabriella | TTO |
| | IVANOVA Mariia | RUS |

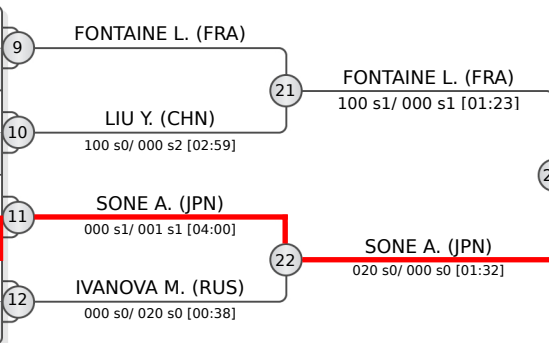

POOL D

| | | |
|--|--------------------|-----|
| | VUKOVIC Helena | CRO |
| | WOJTA Lilli Louise | GER |
| | NIGMATOVA Umida | UZB |
| | MISHINER Yuli Alma | ISR |
| | SOUZA Beatriz | BRA |
| | MARATOVA Nazgul | KAZ |
| | JIA Bingqian | CHN |

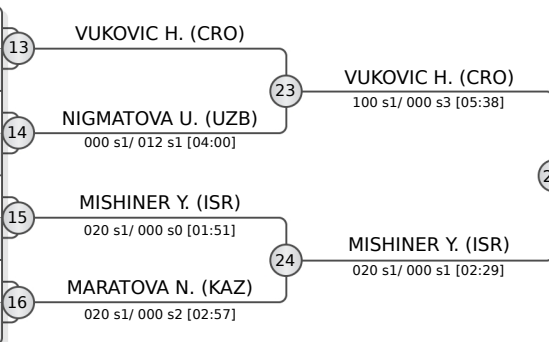

REPECHAGE

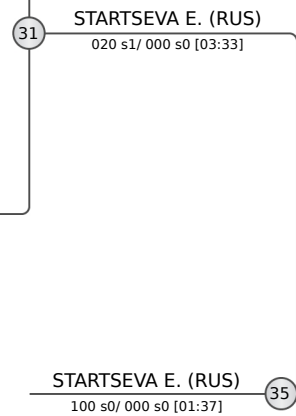
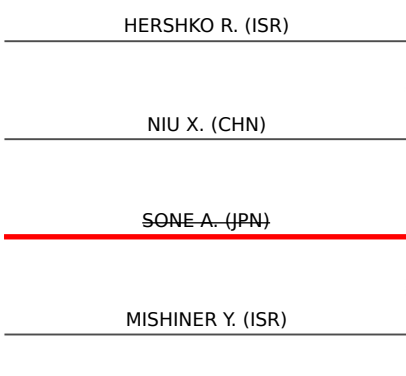

| FINAL RESULTS | |
|---------------|--------------------------|
| 1. | STARTSEVA Elis (RUS) |
| 2. | FONTAINE Lea (FRA) |
| 3. | VUKOVIC Helena (CRO) |
| 3. | AYIMAN Jinesinuer (CHN) |
| 5. | NIU Xinran (CHN) |
| 5. | MISHINER Yuli Alma (ISR) |
| 7. | HERSHKO Raz (ISR) |
| 7. | SONE Akira (JPN) |

